

EUROPEAN MICROWAVE WEEK 2019

SIX DAYS · THREE CONFERENCES · ONE EXHIBITION

PORTE DE VERSAILLES PARIS, FRANCE
29TH SEPTEMBER - 4TH OCTOBER 2019

Exhibition Hours:

Tuesday, 1st October 9.30 - 18.00
Wednesday 2nd October 9.30 - 17.30
Thursday 3rd October 9.30 - 16.30

www.eumweek.com

WM-01 – “Advanced CAD Tools and Techniques for the System Co-Design of Smart Antenna and Transmitter Modules”

Advanced CAD tools for an efficient Antenna / Module co-design

E. Ngoya, S. Mons, T. Reveyrand, C. Menudier, M. Thévenot, J. Lintignat, A. Beaumont

XLIM-Université de Limoges, UMR CNRS 7252, 87068 Limoges, France

www.xlim.fr edouard.ngoya@xlim.fr



Outline

- Context
- Antenna and Radio co-simulation challenges
- XLIM Lab/SCERNE System-level simulation Framework development
- Large array antenna modeling focus
- Power amplifier modeling focus
- Beam steering complexity focus
- Conclusion

Context and objectives for 5G : Achieve efficient beamforming for mass-market applications



Rafale RBE2 – Thales

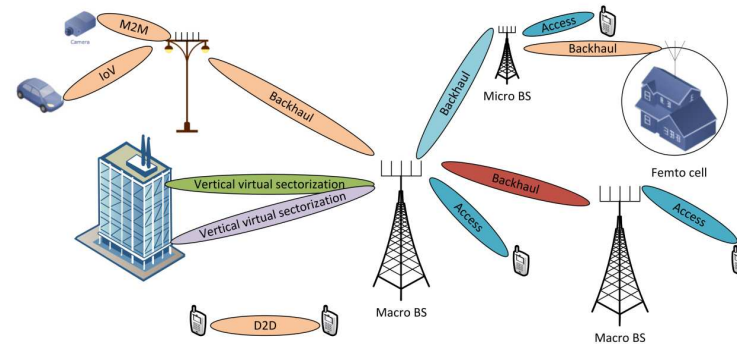

I. Ahmed *et al.*, « A Survey on Hybrid Beamforming Techniques in 5G: Architecture and System Model Perspectives », *IEEE Communications Surveys & Tutorials*, 2018.

Cutting-edge historical niche market

Strong know-how since decades
 → high precision and reconfigurability,
BUT
The cost and complexity are outstanding,
with a reduced overall efficiency !!



Mass market

Requires capabilities close to cutting-edge
BUT
The cost, complexity and efficiency must
comply with mass market applications !!



Requires effective system-level CAD tools to allow efficient
 co-design of Antenna and RF modules

Mass-market application paradigm shift

- High Radio integration density
- No more isolation between Radio and Antenna

Typical example

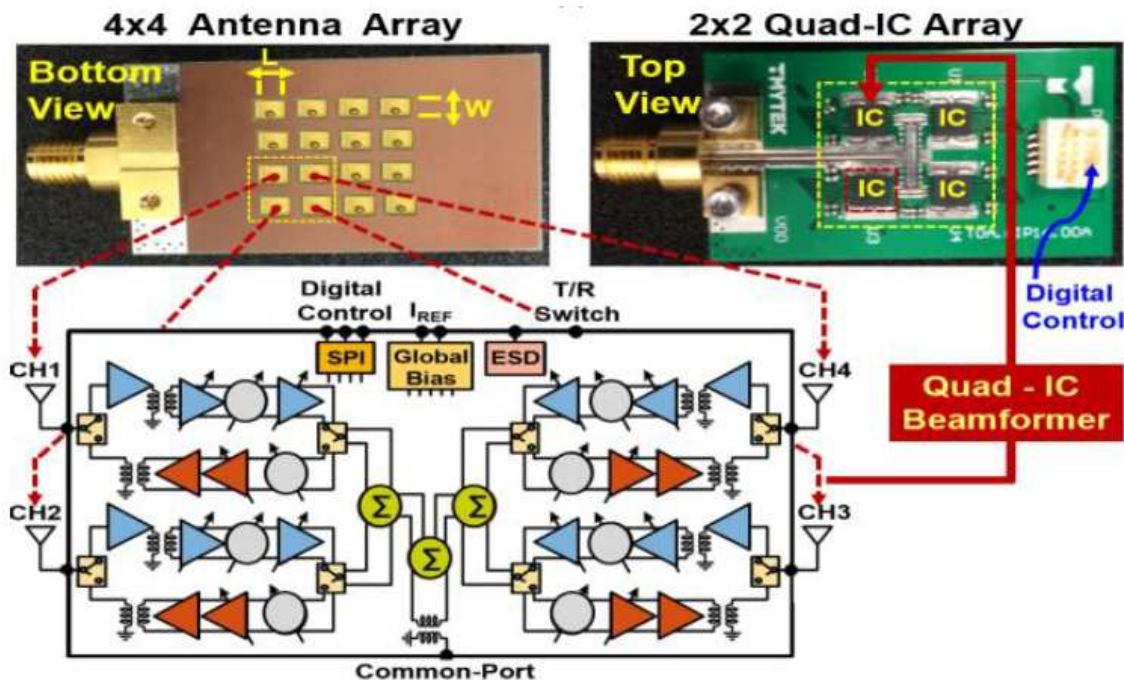

“Millimeter-Wave Beamformer Chips with Smart-Antennas for 5G: Toward Holistic RFSOI Technology Solutions including RF-ADCs”,
Sidina Wane *et al*, WMCS2019



- Requires Radio and Antenna Co-design
- New modeling and simulation challenges

Antenna and Radio Co-simulation challenges

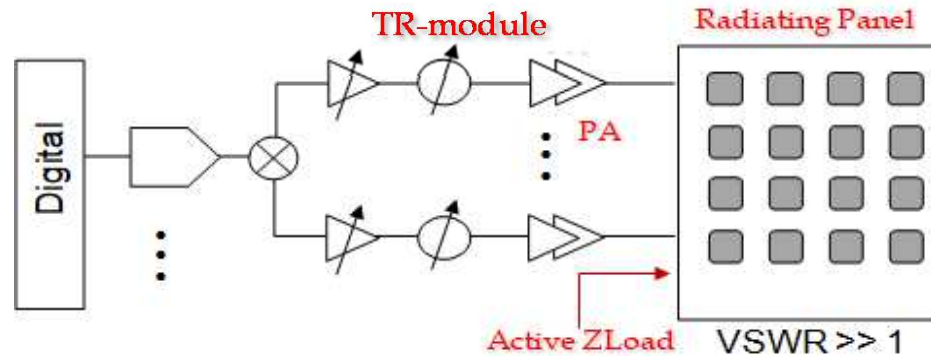

Radio CAD

Circuit-level simulation tools
ADS, Spectre-RF, AWR, ..

Antenna CAD

EM simulation tools
HFSS, CST, EMPro, ..

Radar beamforming CAD

System-level simulation tools
Matlab-Simulink, Systemvue, VSS, ..., In-House tools



Beamforming CAD issues

- Conventional system-level tools are not effective (dataflow simulation type)
→ rely on perfect Radio-Antenna isolation (matched load)
- Effective simulation requires nonlinear Spice type simulation, i.e., Radio CAD type
- Radio CAD are ineffective for beamforming because of the outstanding complexity of the overall system

Antenna and Radio Co-simulation challenges

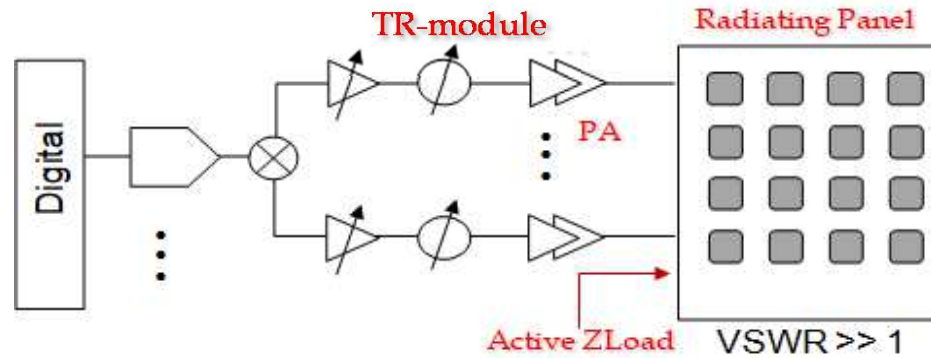

<p>Radio CAD <i>Circuit-level simulation tools</i> ADS, Spectre-RF, AWR, ..</p>	<p>Antenna CAD <i>EM simulation tools</i> HFSS, CST, ..</p>
<p>Radar beamforming CAD <i>System-level simulation tools</i> Matlab-Simulink, Systemvue, VSS, ..., In-House tools</p>	



Necessary system-level simulation tools advancements

- Nonlinear, non-impedance matched and parameterized behavioral model for Radio
- Spice type solver within the beamforming loop

Challenge I : master description heterogeneity/complexity

- Simulation tools/Vendors
Ansys, CST, Keysight, Cadence, NI, .. , In-House
- Test equipments/Vendors
Keysight, NI, Rhode-Schwarz, Anritzu, ..
- Hierarchy
Device-level, Circuit-level, Subsystem-level, Board
- Domain/Formalism
Mechanical, Thermal, EM, Electrical
- People/expertise/language
Digital, Analog BB, RF, Antenna, Packaging

XLIM Lab/SCERNE Behavioral modeling and System-level simulation Framework devpt.

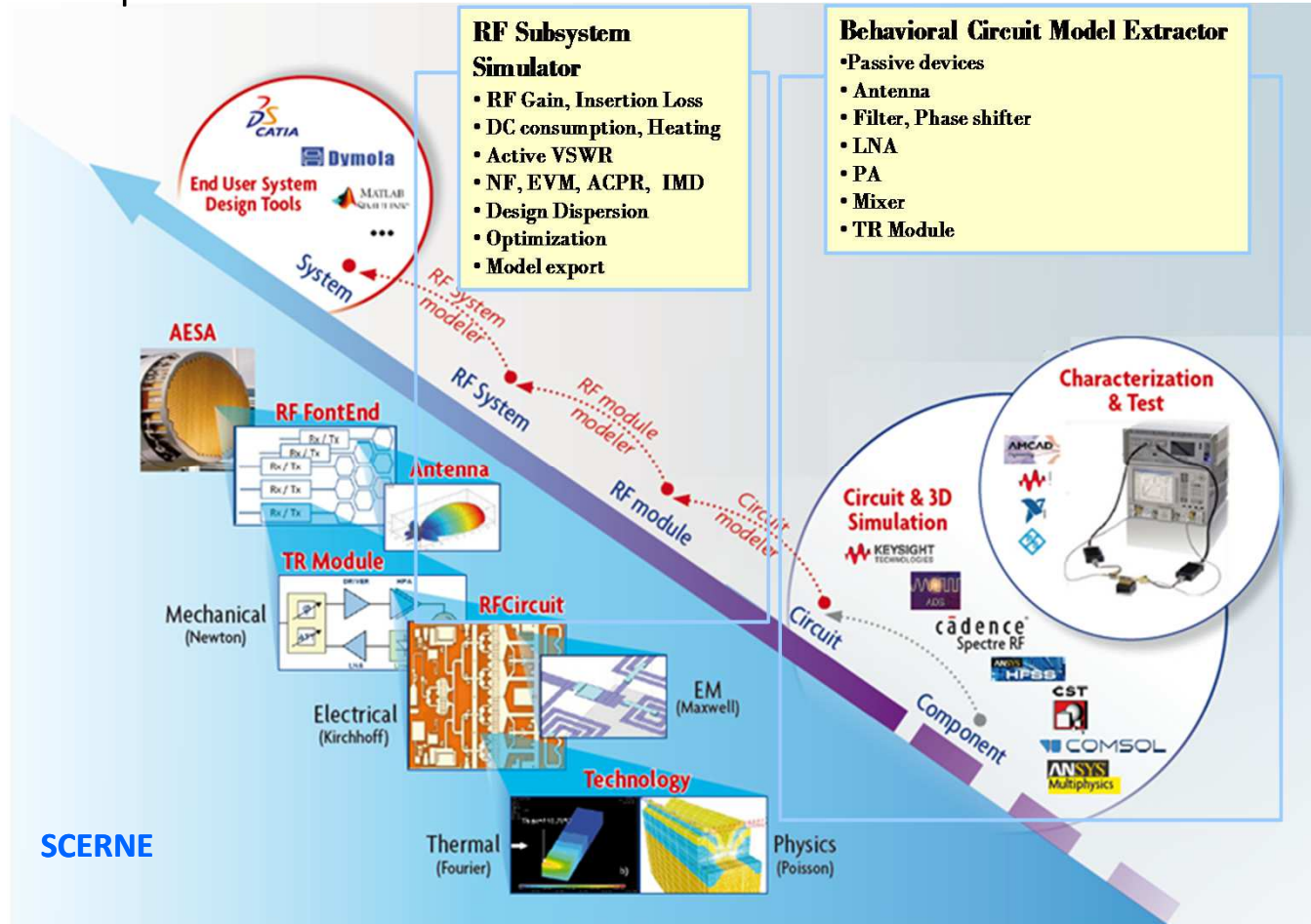

XLIM Lab/SCERNE Behavioral modeling and System-level simulation Framework devpt.

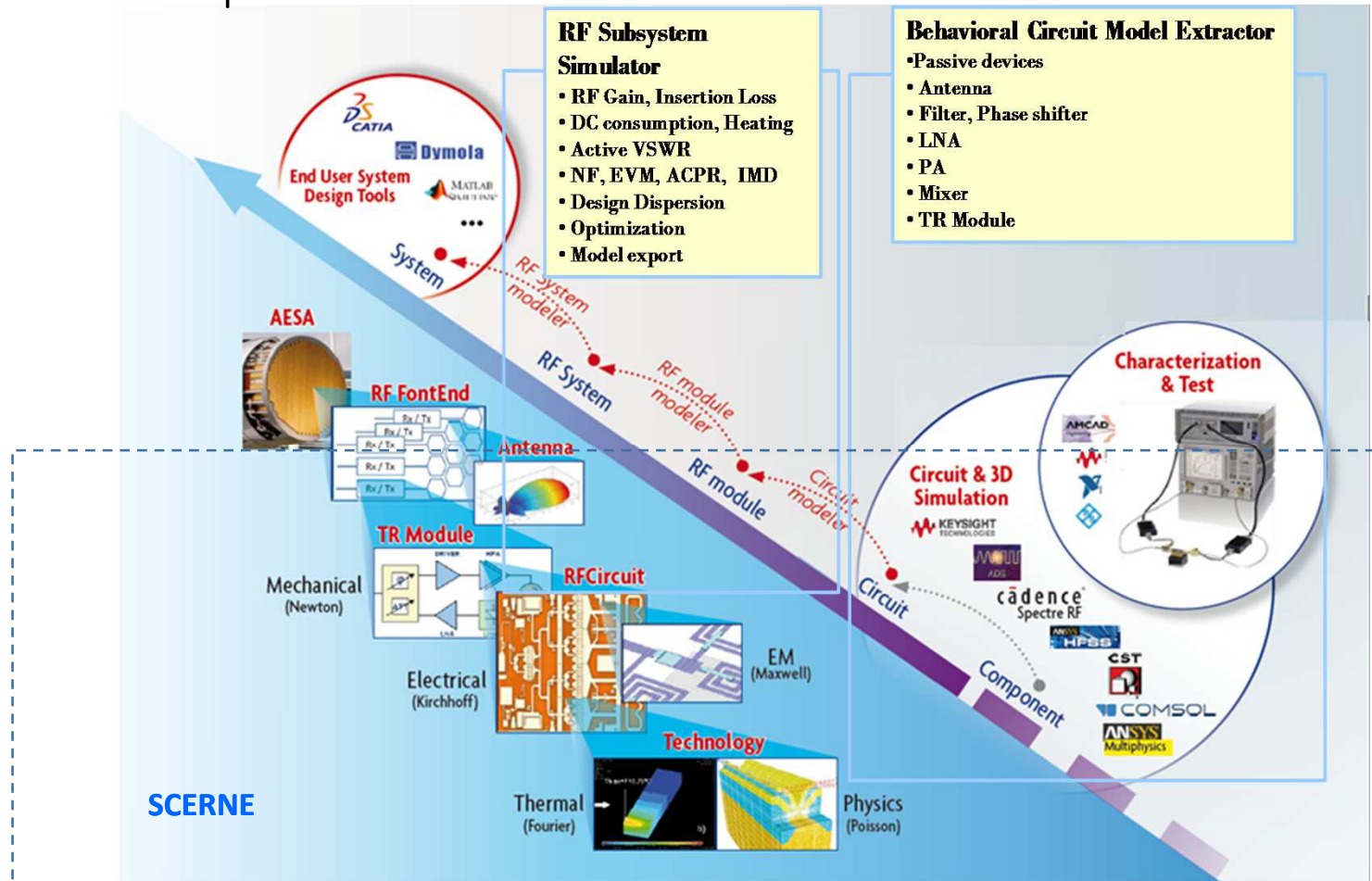

- Collaboration with AMCAD Engineering
- Mature functionalities made available in commercial AMCAD/VISION framework

XLIM Lab/SCERNE Behavioral modeling and System-level simulation Framework

Current Focus : 5G Antenna modeling flow

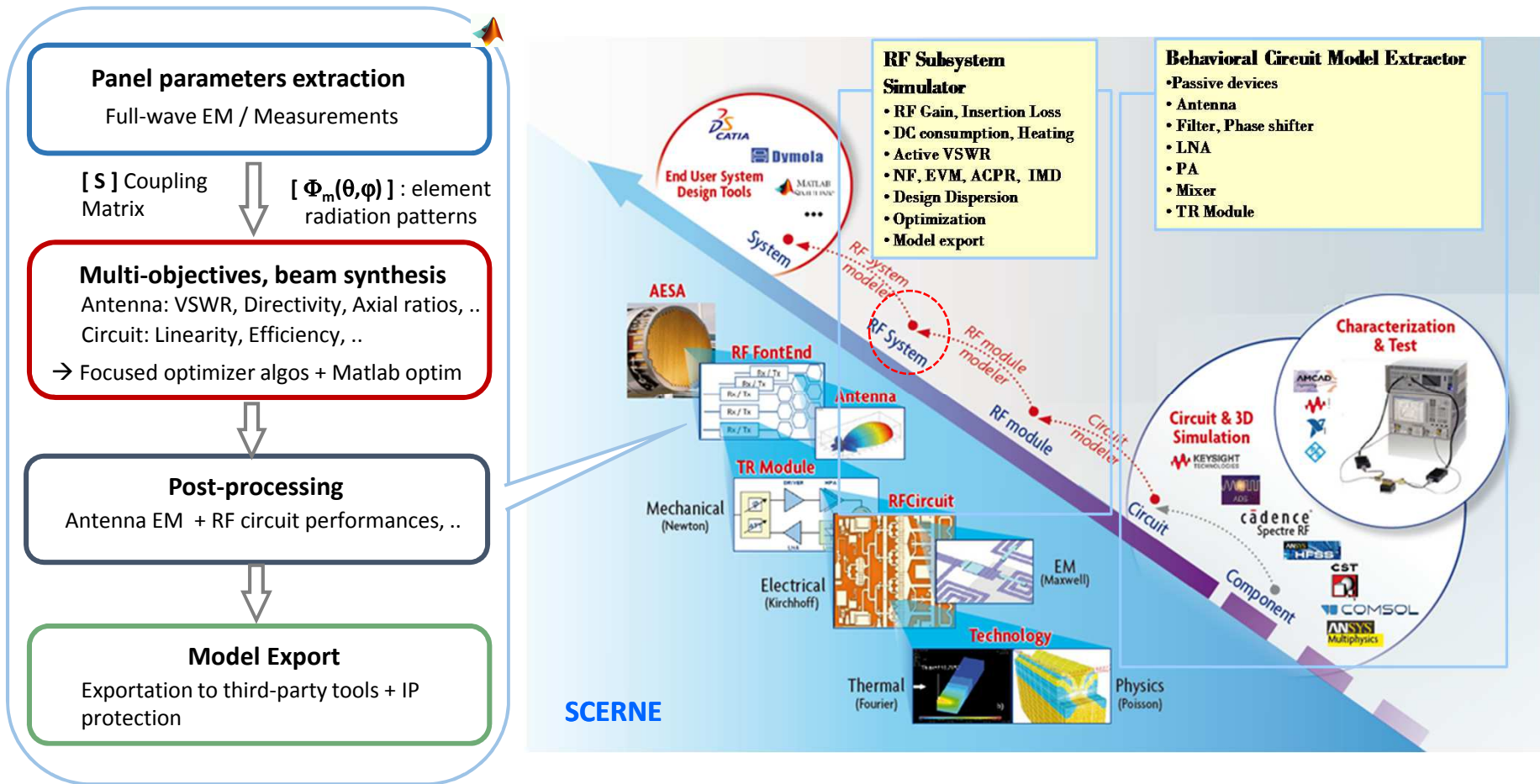

❑ SCERNE Simulator key features

- ✓ Uses Simulink as a schematic capture (opening to Matlab applications)
- ✓ Large palette of behavioral models (LNA, PA, Mixer, SnP, ..), compatible AMCAD/VISION model extractor
- ✓ Performs circuit type (Spice) simulation (notions of current, voltage and impedance)
- ✓ Performs simulation in time domain (envelope-transient analysis) and/or frequency domain (CW) analysis)
- ✓ Complete suite of simulation methods:– swept parameter – statistical analysis – multiple objectives optimization
- ✓ Simple analog HDL language for time and frequency domain device modeling
- ✓ Hidden IP model export mechanism

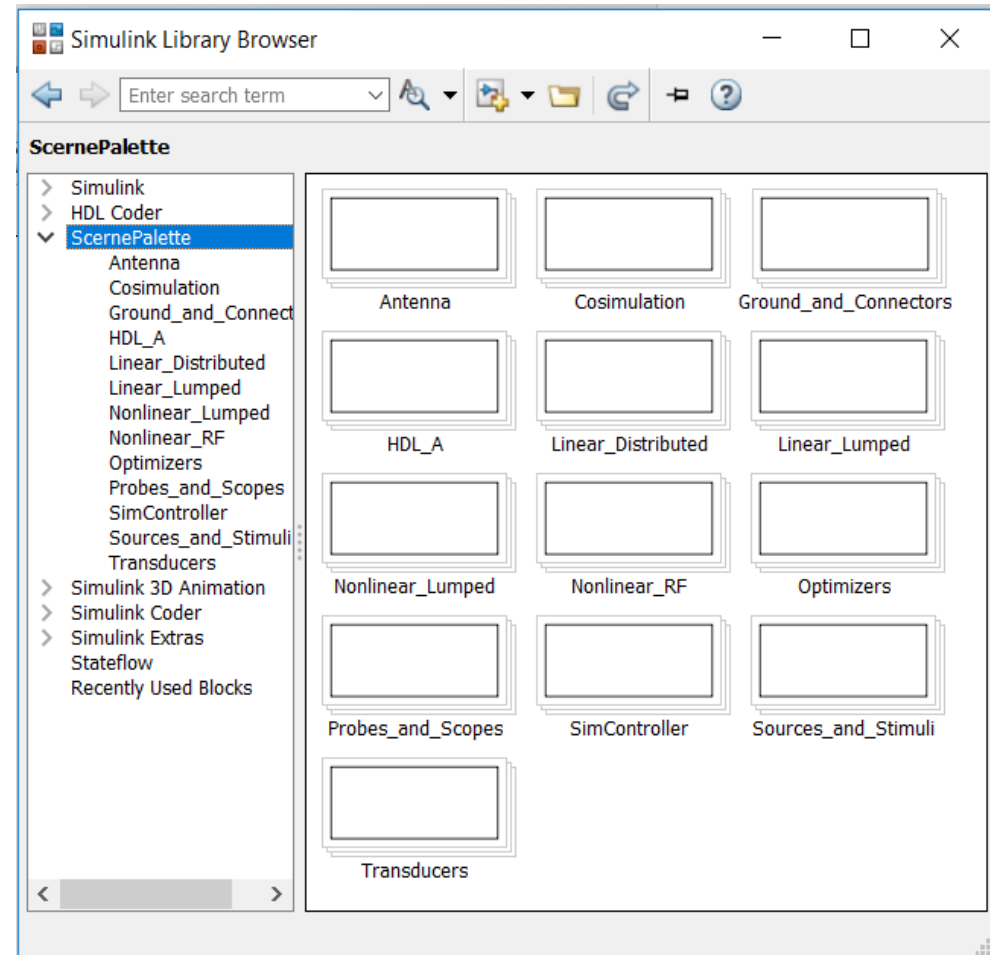

4x4 TX module simulation example with SCERNE

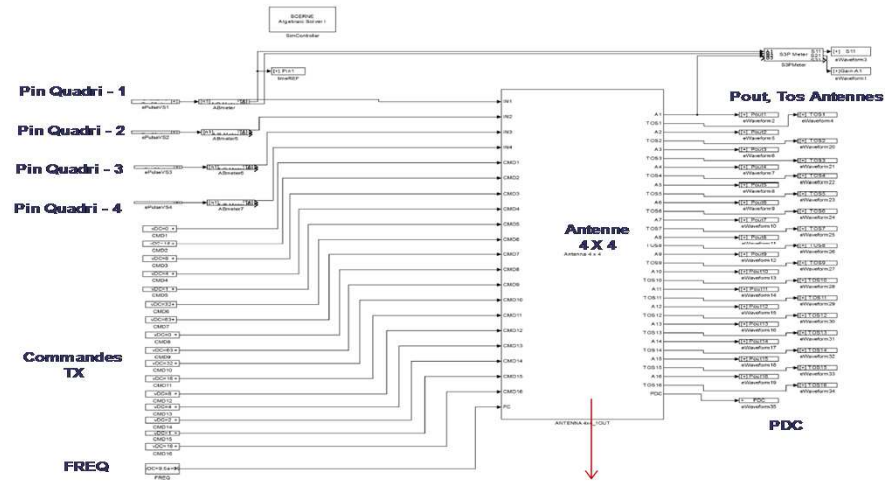

Simulink Schematic

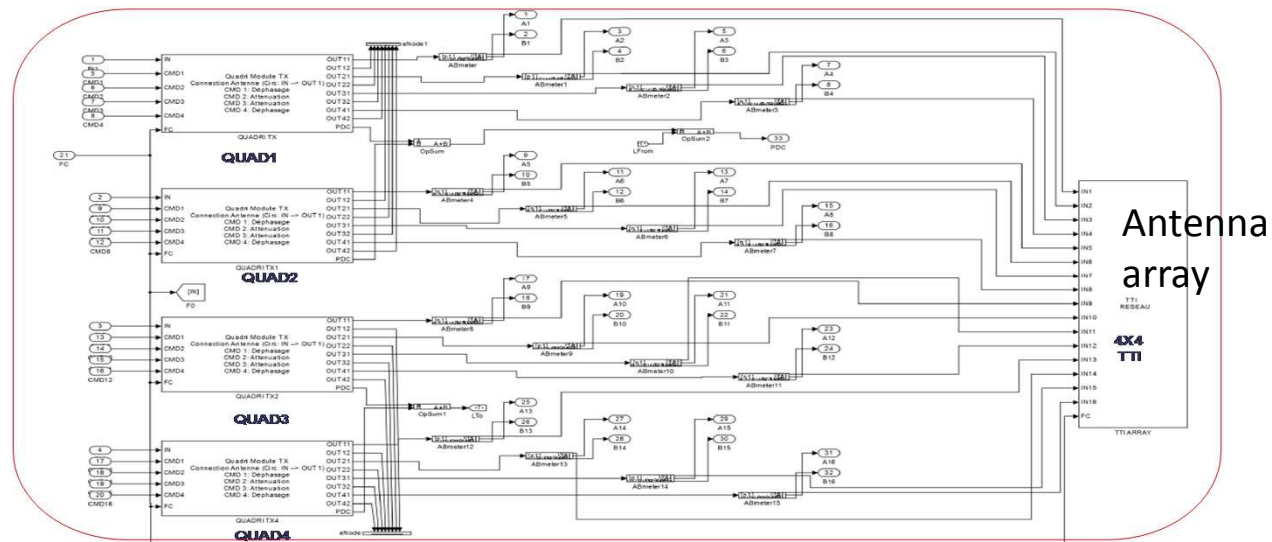

Antenna array

4x4 TX module simulation example with SCERNE, Cont.

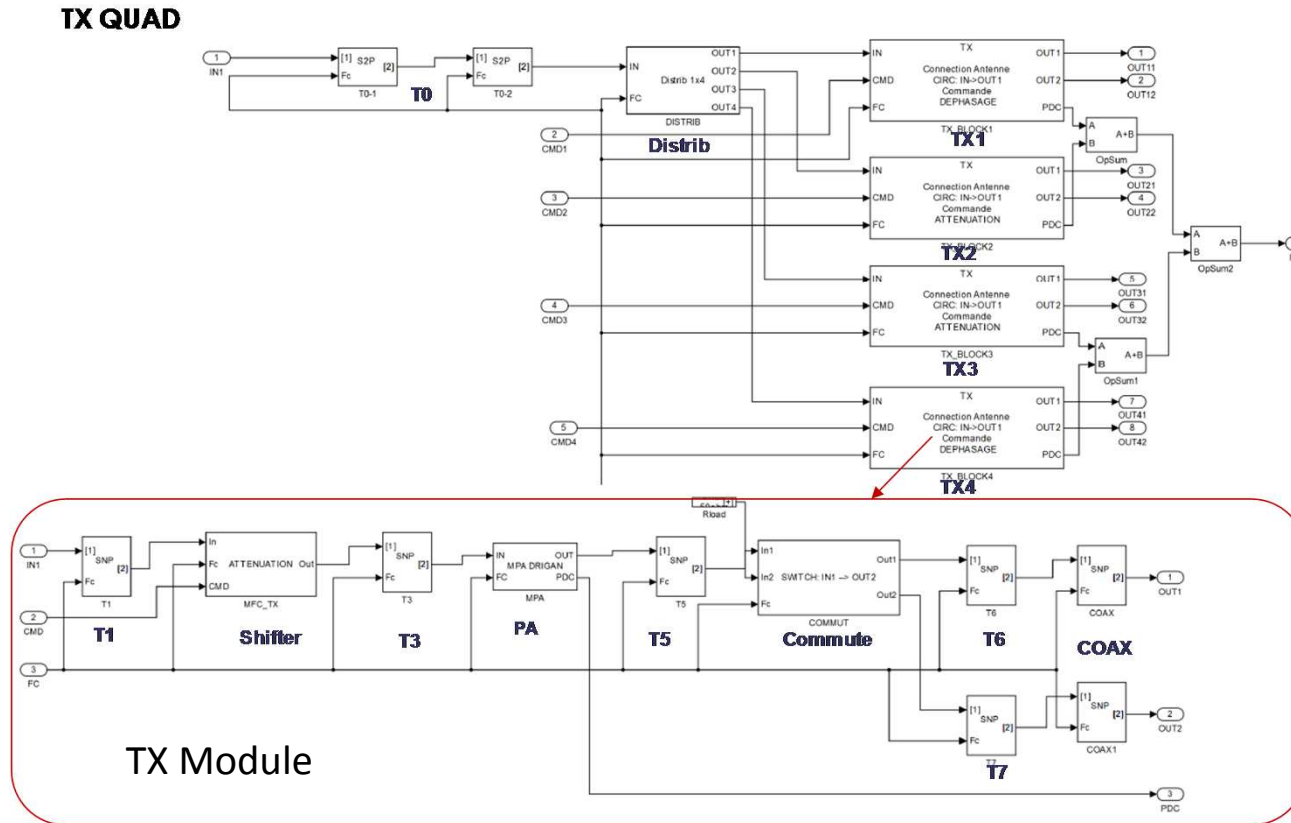

Simulink Schematic

❑ 4x4 TX module simulation example with SCERNE, Cont.

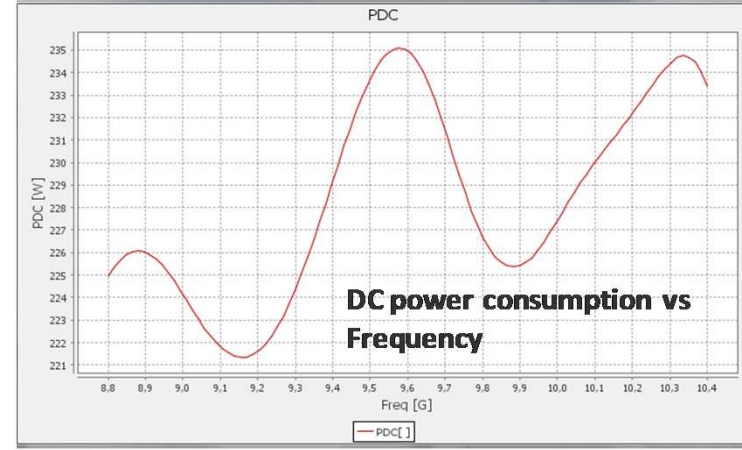
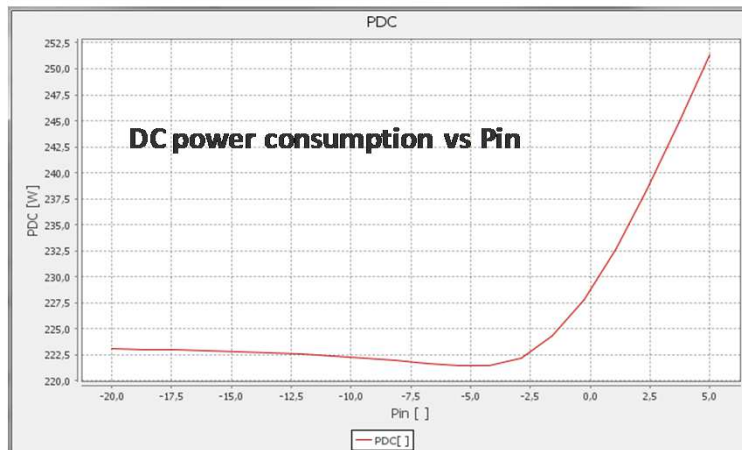
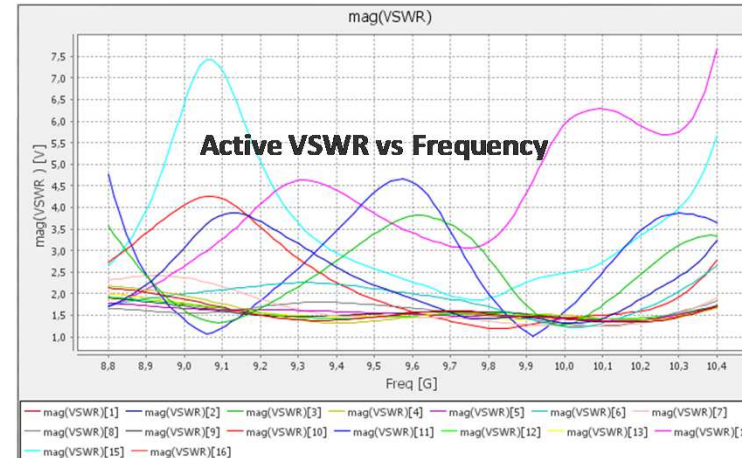
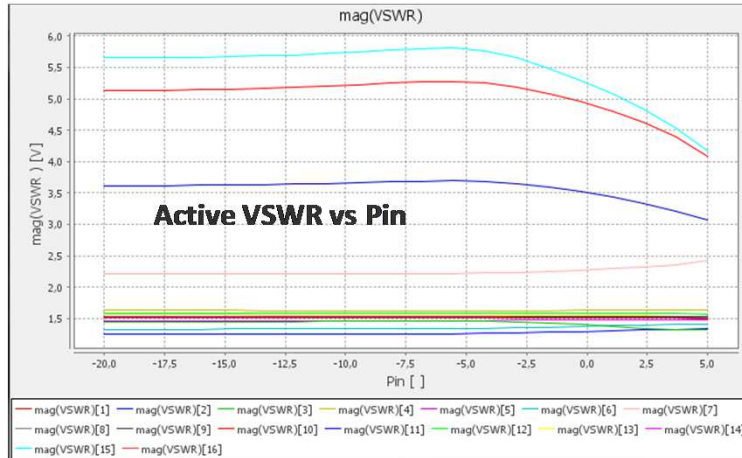

Fast simulation, 16 antennas : 3 sec run time

Challenge II: EM Modeling of large array

- Full-wave EM solver requires outstanding computation resources
- Only affordable by big players
- Expensive and time consuming



There is a need for effective behavioral EM model of antenna array

- Followed approach: Modified Floquet analysis methods

“A large Antenna Array for Ka-band Satcom-on-the-Move Applications – Accurate Modeling and Experimental Characterization”,

B. Lesur *et al*, IEEE Trans. Antenn. and Propag., 2018

Challenge II: EM Modeling of large array, cont.

□ Modified Floquet analysis

16x64 Element array panel

“A large Antenna Array for Ka-band Satcom-on-the-Move Applications – Accurate Modeling and Experimental Characterization”,
B. Lesur *et al*, IEEE Trans. Antenn. and Propag., 2018

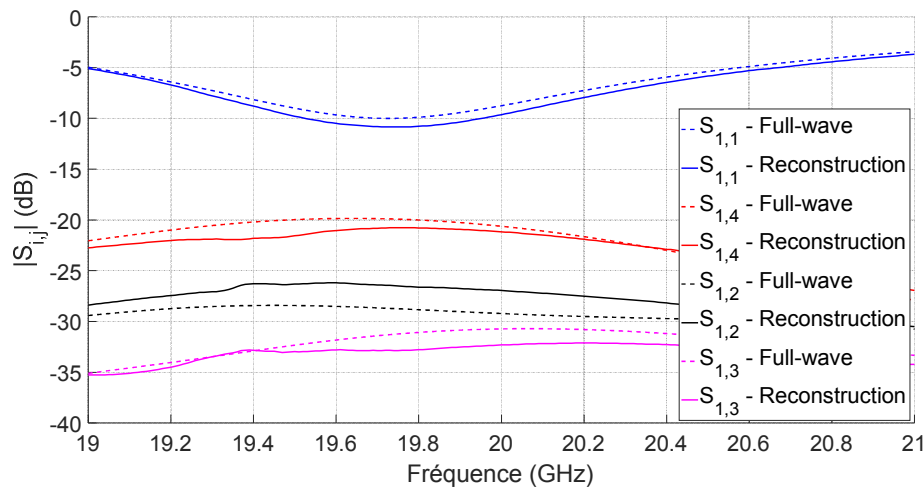
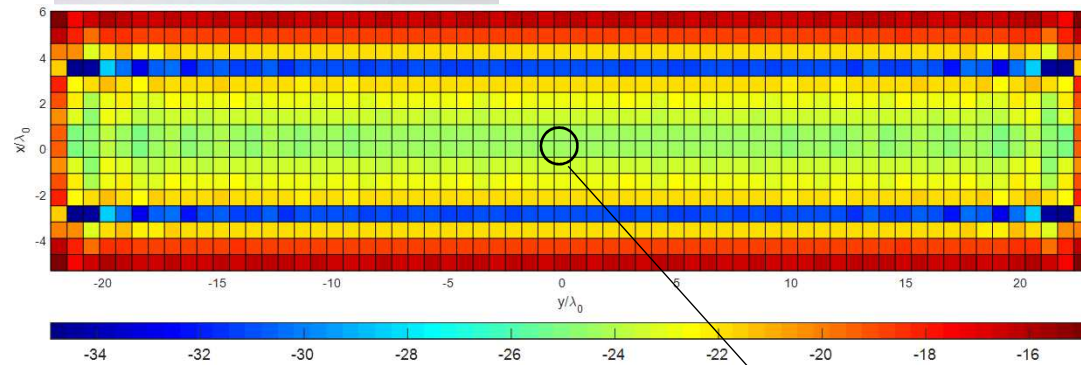

Active reflection coeff (dB)

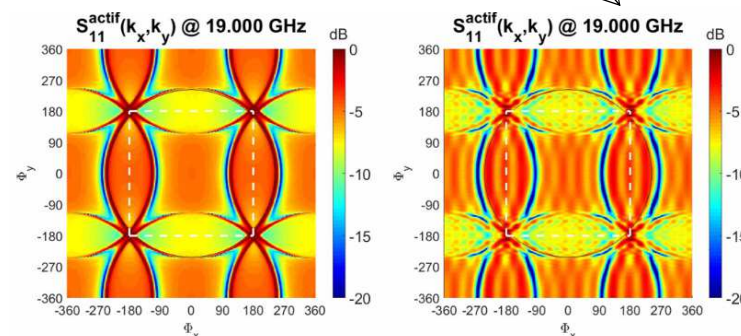

Ideal Floquet

Model

Challenge III: Modeling of wideband PA and DPD

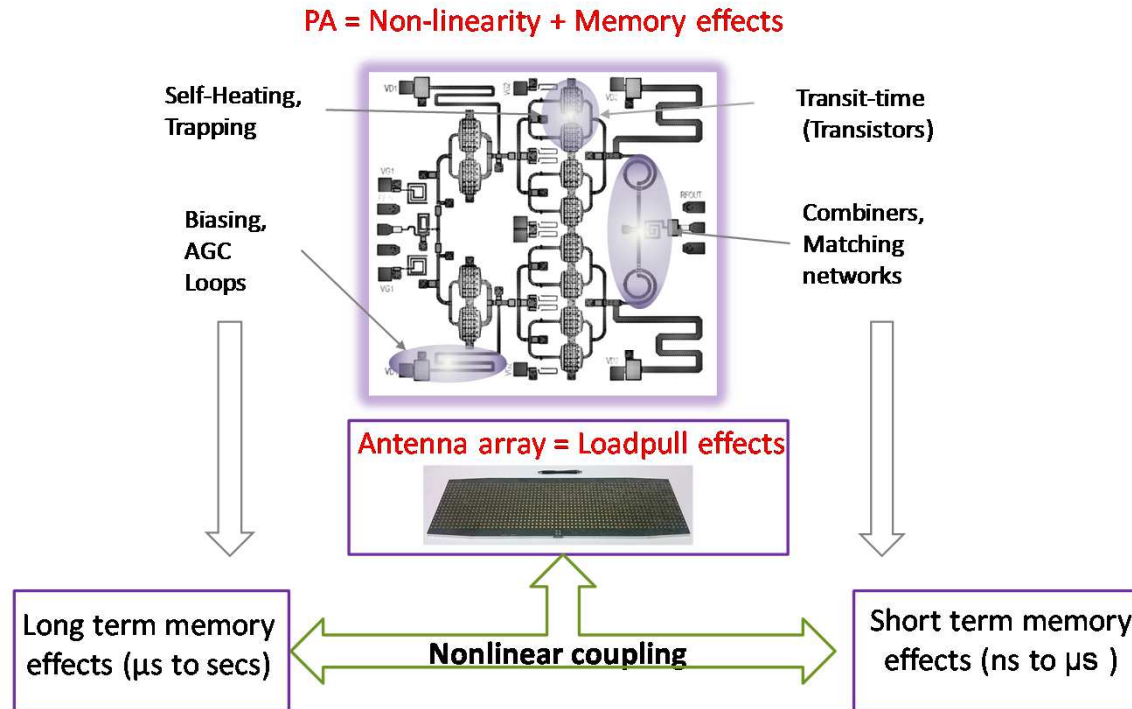

Nonlinearity + memory + antenna loadpull effects severely impact wideband modulation signals, with consequences:

- Deriving PA model is very challenging
- Conventional black-box DPD algorithms do not perform well

Challenge III: Modeling of wideband PA and DPD, cont.

□ Grey-box behavioral PA model

” Progress for Behavioral Challenges:
 A Summary of Time-domain Behavioral
 Modeling of RF and Microwave Subsystems”
 E. Ngoya *et al*, IEEE Microwave Magazine, 2014

➔ TPM model

- Pseudo equivalent network
- Dissociate short and long term memories
- Identify nonlinear integral equations, using two-tone signal and load-pull

$$Y(t) = Y_{ST}(t)[1 + M_{LT}(t)]$$

$$Y_{ST}(t) = \int_0^t h_{ST}(|X(t-\tau)|, \tau) X(t-\tau) d\tau$$

$$M_{LT}(t) = \int_0^t h_{LT1}(|X(t-\tau)|, \tau) |X(t-\tau)| d\tau + \int_0^t h_{LT2}(|X(t-\tau)|, \tau) \frac{dX(t-\tau)}{dt} d\tau$$

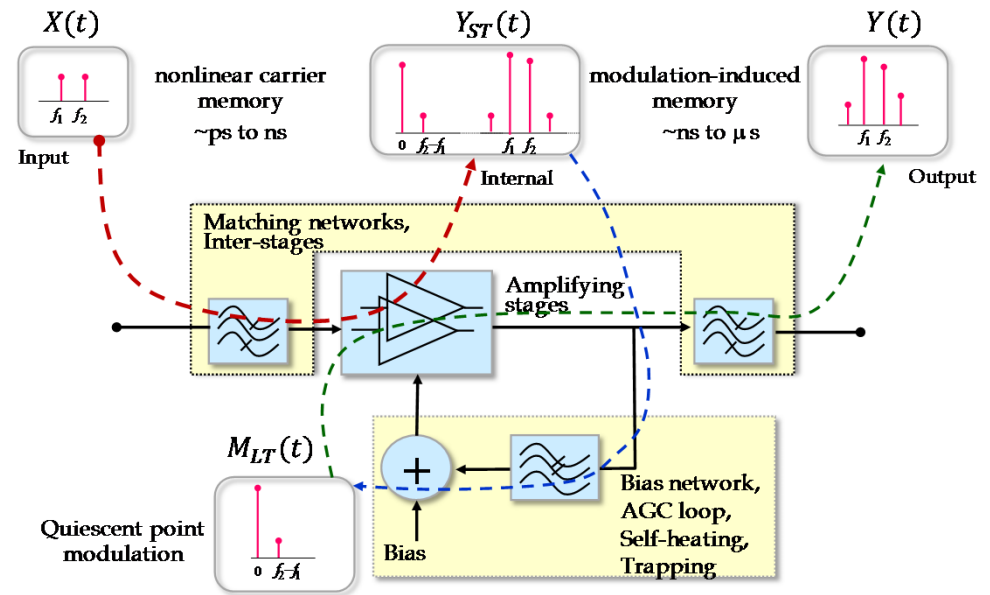

Challenge III: Modeling of wideband PA and DPD, cont.

□ Typical comparison with conventional black-box models

12 Watts multistage LDMOS RF-PA – 2.6GHz - NXP/MD71C2012N

Peak Power = 5dB Gain compression

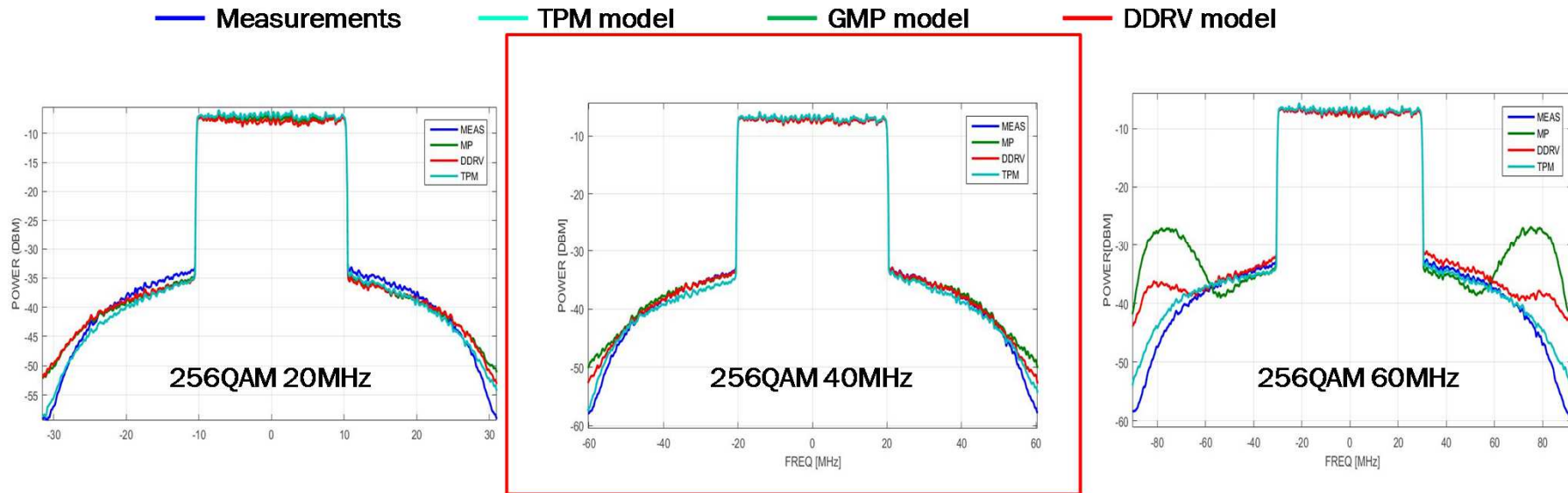

Learning signal for the conventional models: GMP and DDRV

Challenge III: Modeling of wideband PA and DPD, cont.

□ Typical comparison with conventional black-box models

12 Watts multistage LDMOS RF-PA – 2.6GHz - NXP/MD71C2012N

Peak Power = 5dB Gain compression

✓ *Signal change from 256QAM to LTE, same peak power*



- Conventional models need reconstruction for every signal, bandwidth and power level change
- TPM model is providing a robust PA modeling solution
 - ✓ similar performance for all signal, bandwidth and power level

— Meas. — TPM model — GMP model — DDRV model

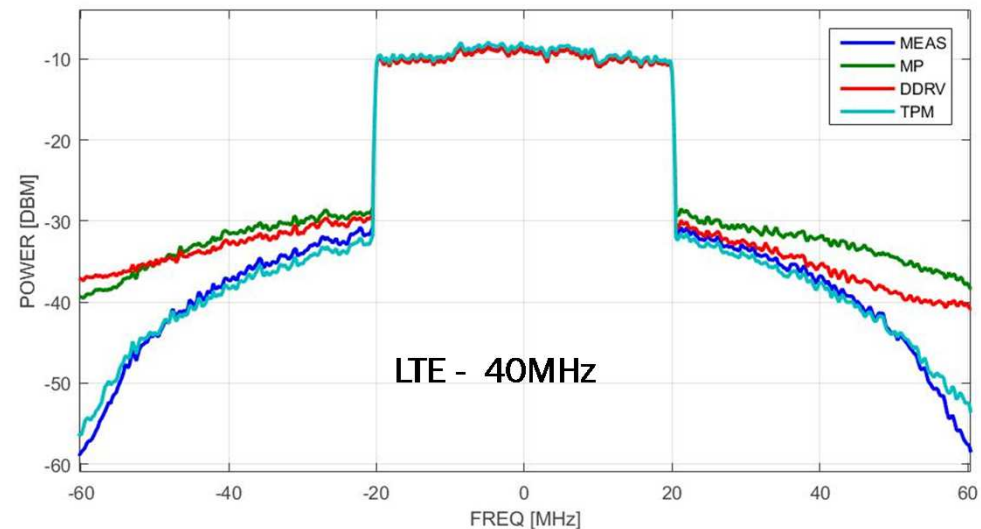

Challenge IV: Beam steering precision

- ❑ Impact of antenna loadpull on the radio make beam steering algorithms and precise system calibration highly challenging



A mitigation approach: Hybrid vs Full Active network

Hybrid steering uses a fraction of passively terminated antenna elements as an artefact to maintain mismatch of active elements low, through mutual coupling.

Challenge IV: Beam steering precision

- ❑ Impact of antenna loadpull on the radio make beam steering algorithms and precise system calibration highly challenging



A mitigation approach: Hybrid vs Full Active network

Hybrid steering uses a fraction of passively terminated antenna elements as an artefact to maintain mismatch of active elements low, through mutual coupling.

"Optimization of the VSWR of Reconfigurable Antennas with a Coupled Multielement Concept",
A. Alzein, *et al*, Antennas and Propagation (EUCAP), 2018.

Challenge IV: Beam steering precision

□ Hybrid steering concept

- Maximize elements' mutual coupling
- Terminate a fraction of elements with passive reactive loads
- Use passive load as a minimizer for active elements' mismatch

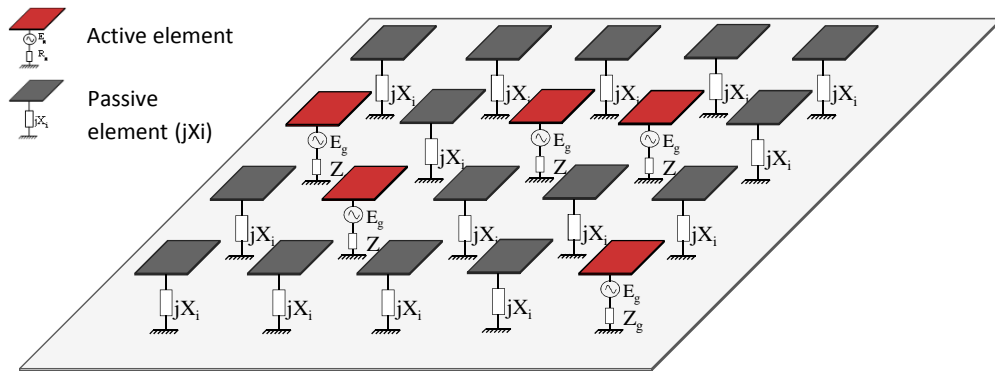

Results in simplification of beamforming network, and reduced active channels

Made possible by Antenna-Circuit co-design

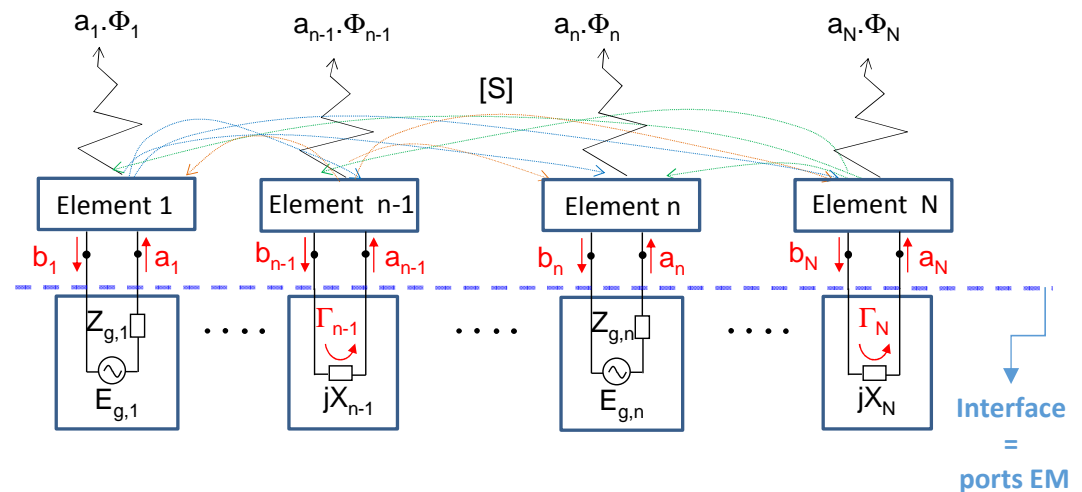

Challenge IV: Beam steering precision

□ Proof of concept: Hybrid network based on monopole lattice @2.45 GHz



7x7 monopoles connectorized
with RTPS @ 2.45 GHz (10%
bandwidth)

✓ Efficient beamforming with **one
active element over 49**

|S_{ii}| active ≤ -12 dB {2.35-2.5 GHz}

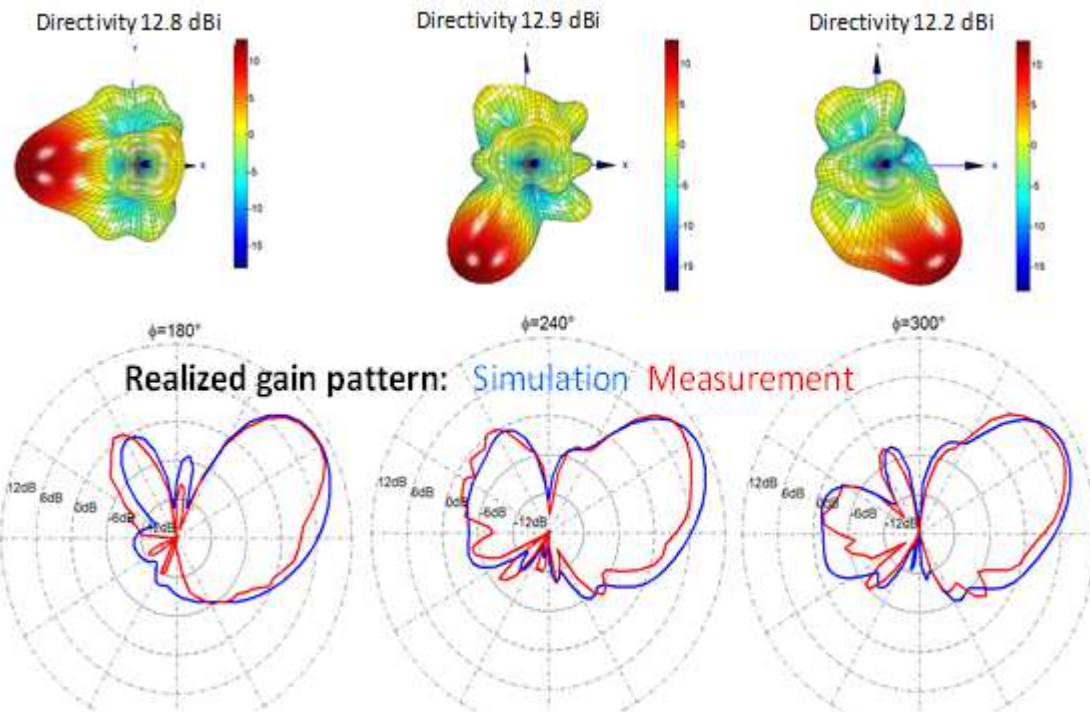

C. Menuétier, M. Thevenot, E. Arnaud, A. Oueslati, F. Fezai, T. Monédière, N. Chevalier, S. Reynaud, "Synthesis of a 2D Reconfigurable Parasitic Element Antenna", *Proceedings of the 46th European Microwave Conference (EuMC)*, London, 3-7th October 2016

Summary

- Beamforming for 5G mass-market applications
- Antenna and Radio co-simulation challenges
- XLIM Lab/SCERNE System-level simulation Framework help bridge heterogeneity/complexity gaps in system design
- Proposed solutions for
 - Large array antenna modeling
 - Power amplifier modeling
 - Beam steering complexity reduction

Thank you!