



HAL
open science

Optimal bounds and matching networks of fixed degree for frequency varying impedances

David Martinez Martinez, Adam Cooman, Fabien Seyfert, Martine Olivi,
Stéphane Bila

► **To cite this version:**

David Martinez Martinez, Adam Cooman, Fabien Seyfert, Martine Olivi, Stéphane Bila. Optimal bounds and matching networks of fixed degree for frequency varying impedances. EuCAP 2020 - European Conference on Antennas and Propagation, Mar 2020, Copenhague / Online, Denmark. hal-03047706

HAL Id: hal-03047706

<https://unilim.hal.science/hal-03047706>

Submitted on 8 Dec 2020

HAL is a multi-disciplinary open access archive for the deposit and dissemination of scientific research documents, whether they are published or not. The documents may come from teaching and research institutions in France or abroad, or from public or private research centers.

L'archive ouverte pluridisciplinaire **HAL**, est destinée au dépôt et à la diffusion de documents scientifiques de niveau recherche, publiés ou non, émanant des établissements d'enseignement et de recherche français ou étrangers, des laboratoires publics ou privés.

Optimal bounds and matching networks of fixed degree for frequency varying impedances

David Martínez Martínez*, Adam Cooman†, Fabien Seyfert‡, Martine Olivi§, Stéphane Bila¶,
 *†‡INRIA Sophia Antipolis, 2004 Route des Lucioles, 06902 Valbonne, France
 §Ampleon Netherlands, Halfgeleiderweg 8, 6534 AV Nijmegen, Netherlands
 ¶Université de Limoges, CNRS, XLIM, UMR7252, F-87000 Limoges France
 *david.martinez@inria.fr †adam.cooman@ampleon.com ‡fabien.seyfert@inria.fr §martine.olivi@inria.fr
 ¶stephane.bila@xlim.fr

Abstract—In this paper, matching networks of finite degree are computed. Additionally the presented results are compared with the lower fundamental bounds available in the literature. These bounds are used to certify the optimality of the provided matching networks in function of the attained matching tolerance. To illustrate the presented results, two different examples of matching problems are presented.

Index Terms—antennas, filter synthesis, matching, bounds.

I. INTRODUCTION

Bounds for the problem of matching have been already computed by numerous authors in the literature. These bounds were first introduced in [1] where the problem of matching an RC -load is considered as the design of a lowpass filtering network where an RC -element is fixed. In [2] the problem was extended to the case of a generic load by using the *Darlington equivalent* and reformulated in [3] as a complex interpolation problem. Additionally in [4] the matching problem was solved optimally by considering the broader class of infinite dimension functions H^∞ and therefore providing hard bounds for the matching problem in finite dimension. Nevertheless the computation of matching networks of finite degree which approach as closely as possible the lower bounds is still a current issue.

In [5] a method based on convex optimisation was presented. This technique provides us, with hard lower bound for the problem of matching when a matching load of finite degree is considered. These bounds can be considered as an extension of the results computed in [4] to the case of a matching network of finite degree.

In this work we provide a study comparing the hard lower bounds to the best matching tolerance attainable for a given load together with the result provided by a rational matching network of a given degree. In this context, two examples of matching network synthesis are presented. In the first one we consider the problem of antenna matching while in the second one we deal with a double matching problem by designing the input and output matching network for a LNA (low noise amplifier).

II. THEORY

In this paper we use a novel algorithm for the computation of matching networks which is based on the pointwise match-

ing algorithm introduced in [6]. This algorithm is implemented as part of the matlab toolbox *PUMA-HF* (see [7]). The matching problem considered in this work aims to minimise the reflection of the power transmitted to a given load within a specified frequency band. The load is represented as a 2-port device L in Fig. 1. Usually the power is transmitted to the load through a filter F that rejects out of band signals. Both devices, the filter together with the load compose the global system S .

A. The matching problem

In this section we state the matching problem as the minimisation over the passband \mathbb{I} of the magnitude of the global reflection $|S_{11}|$ which is expressed as the pseudohyperbolic distance between F_{22} and L_{11} . We have therefore the following problem

Problem 1 (Matching problem).

$$\text{Find:} \quad \psi_{opt} = \min_{F_{22}} \max_{s \in \mathbb{I}} \left| \frac{F_{22} - \overline{L_{11}}}{1 - F_{22}L_{11}} \right| \quad (1)$$

Additionally we suppose that the zeros of the functions F_{21} and F_{12} are fixed as it is customary in classical filter synthesis.

Note that in [5] hard lower bounds ψ_{min} have been provided for the solution to Problem 1 such that

$$\psi_{min} \leq \psi_{opt} \quad (2)$$

This bound ψ_{min} are the result of a fundamental limitation imposed by load on the global systems that can be realised. Note for instance that in the case of a frequency invariant load we have $\psi_{min} = 0$, namely any matching level is possible. These lower bounds can now be used to certify the optimality of the computed matching networks.

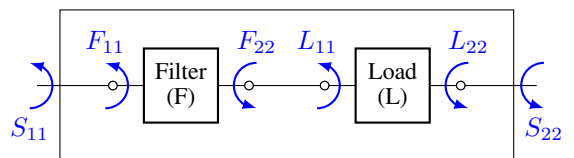

Fig. 1. Global system composed of the cascade of the matching filter with the load and reflection coefficients.

III. EXAMPLES

A. Small superdirective antenna

As a first and simple example, we consider the problem of matching the small super-directive antenna presented in [8] in the interval \mathbb{I} defined as

$$\mathbb{I} = [870, 900] \text{ MHz}. \quad (3)$$

The reflection L_{11} of this antenna is shown in fig. 2. Note the mismatch of the reflection L_{11} around 870 MHz

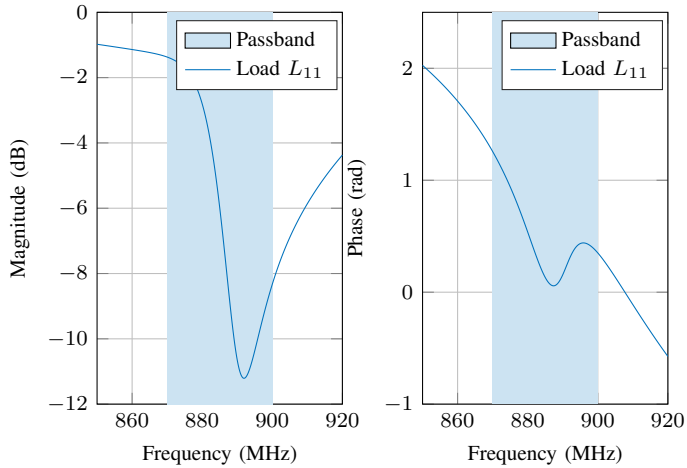

Fig. 2. Superdirective small antenna

In fig. 3 we show the lower bound ψ_{min} as well as the obtained matching level ψ_{opt} as a function of the degree K of the matching filter from $K = 1$ to $K = 12$. These values are also listed in table I. Note the significant improvement of the reflection level around 870 MHz for any value of K obtaining a matching level between -6.5 and -9 dB. It is also interesting to remark the proximity of the obtained level ψ_{opt} to the lower limit ψ_{min} . Indeed in fig. 4 we plot the extremely small optimality gap, which quickly converges towards zero. This fact together with the local optimality of the filter that provides the matching level ψ_{opt} certify the obtained result.

B. Double matching of a low noise amplifier

In this section, we design the input and output matching network for a low-noise amplifier based around the transistor infineon BFP520. We can see in Fig. 6 the ADS schematic of the transistor with the biasing network which has been used to simulate scattering parameters and noise parameters of the transistor.

The schematic of the desired system is shown in Fig. 7. The frequency band considered in this example is mainly limited by the design of the biasing network. In this case we target the band between 2 GHz and 4 GHz:

$$\mathbb{I} = [2GHz, 4GHz]$$

Degree (K)	ψ_{opt} dB	ψ_{min} dB
1	-6.5028	-7.0389
2	-7.4389	-7.7777
3	-7.9916	-8.1925
4	-8.3218	-8.4512
5	-8.5351	-8.6237
6	-8.6815	-8.7444
7	-8.7859	-8.8320
8	-8.8629	-8.8977
9	-8.9212	-8.9480
10	-8.9663	-8.98745
11	-9.0020	-9.0188
12	-9.0306	-9.0442

TABLE I
OBTAINED MATCHING LEVEL VS LOWER BOUND.

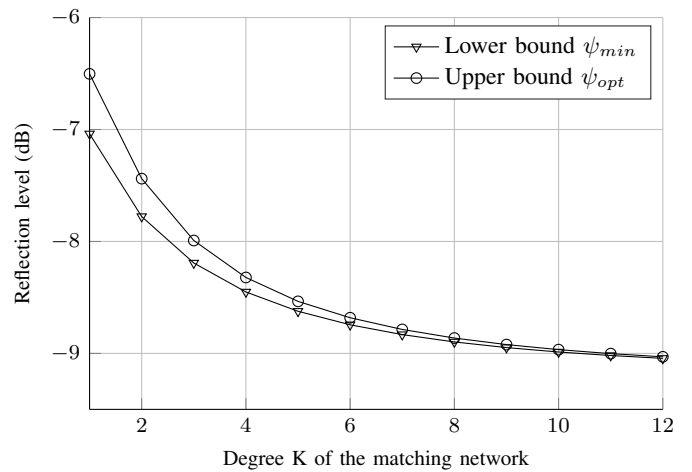

Fig. 3. Bounds for the reflection level

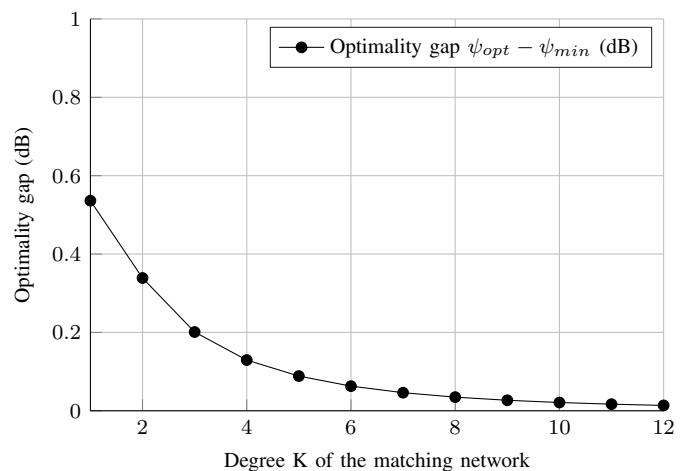

Fig. 4. Optimality gap.

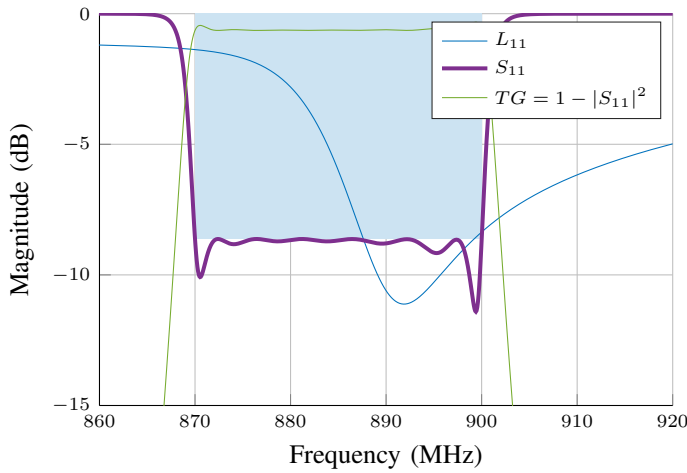

Fig. 5. Global response S_{11} and transducer gain obtained with the load in Fig. 2

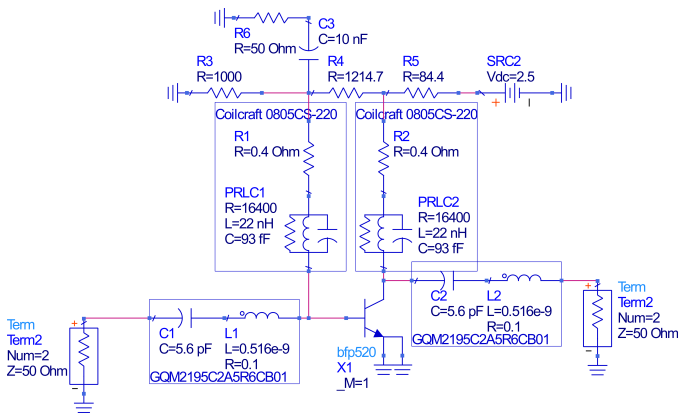

Fig. 6. Infineon transistor BFP520 with the biasing network.

1) *Input matching*: First we design the input matching network of degree 1, such that the transistor input sees the reflection coefficient S_{opt} which provides the optimal noise figure for the LNA. We do this by synthesising a matching network to match the reflection $\overline{S_{opt}}$. The matching network will show at the output the best approximation of the function S_{opt} (Fig. 8). Thus we obtain a matching network matched at the input to 50Ω and synthesizing S_{opt} at the output.

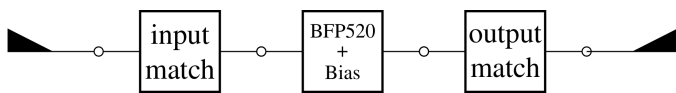

Fig. 7. Schematic of the global system with input and output matching networks.

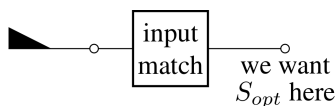

Fig. 8. Input matching network.

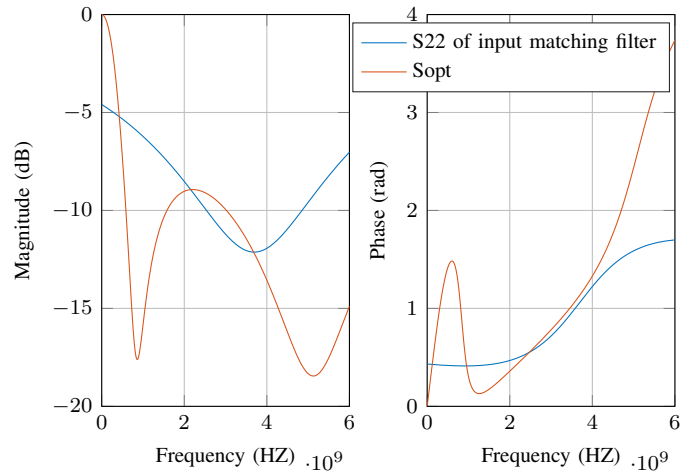

Fig. 9. Output reflection of the input matching network.

2) *Output matching*: Once we have the input matching network, we compute the S_{22} parameter of the combination of the input matching with the transistor and compute the matching filter for the total network shown in Fig. 10. Note

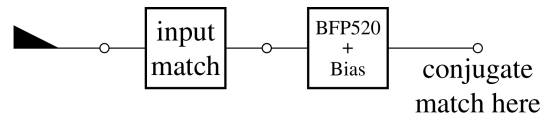

Fig. 10. Output matching problem.

that this design approach will not work every time. It is possible that stability issues are encountered at this stage, but working with an unconditionally stable transistor+biasing will resolve this issue.

Now we compute the matching network for the transistor output by means of Problem 1. We compare in this case the result obtained with a network of degree K from 1 to 6. Figure 11 shows the level ψ_{opt} obtained with the computed matching network as well as the lower hard limit ψ_{min} , both listed in table II. We obtain a matching level below $-20dB$ in any case. Similarly to the input matching network, we pick a degree $K = 1$ for the output matching network, obtaining the response shown in Fig. 12.

Degree (K)	ψ_{opt} dB	ψ_{min} dB
1	-33.4608	-26.0317
2	-42.1157	-36.6857
3	-48.8488	-45.3051
4	-53.6380	-51.4173
5	-57.0200	-55.4438
6	-59.5237	-58.2677

TABLE II
OBTAINED MATCHING LEVEL VS LOWER BOUND FOR THE LNA'S OUTPUT MATCHING.

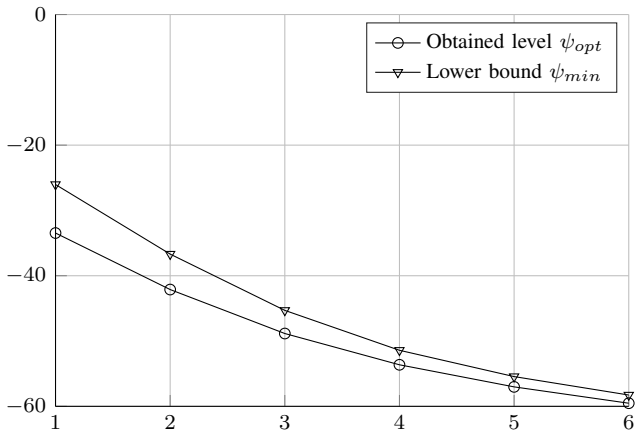

Fig. 11. Lower bounds and obtained reflection level for the output matching problem.

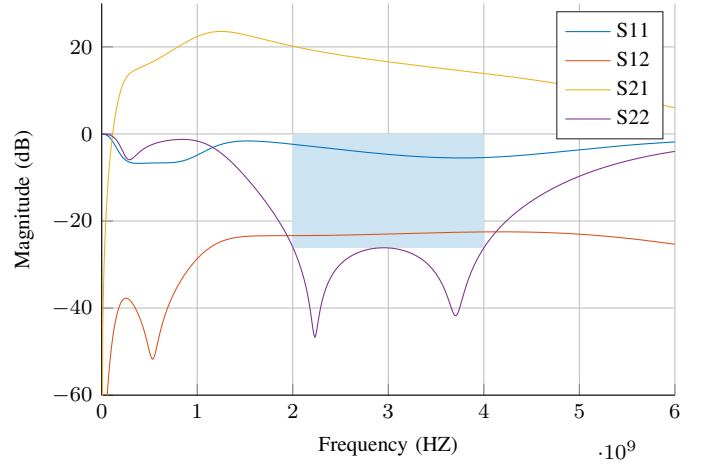

Fig. 13. Global response of the network shown in Fig. 14.

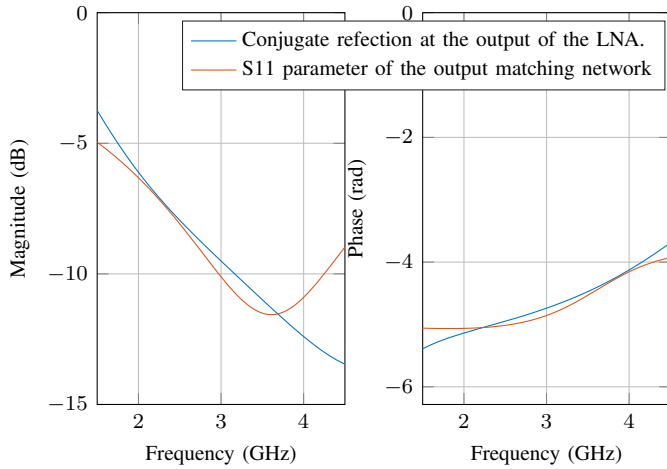

Fig. 12. Input reflection of the output matching network.

3) *Global system*: We can now use the synthesized input and output matching networks, both of them chosen to be of degree 1 to reconstruct the global system of the LNA shown in Fig. 7. We obtain the schematic in Fig. 14 where the input and output matching network have been included. Furthermore we provide in Fig. 13 the global response of the network shown in Fig. 14. It can be noted the obtained matching level on the parameter S_{22} which is below -20dB within the the whole band $\mathbb{I} = [2GHz, 4GHz]$.

IV. CONCLUSION

In this work a practical algorithm for the computation of matching networks of finite degree is introduced and several examples are presented. The computed matching networks are certified by comparing the provided matching level with the fundamental lower bounds available in the literature.

ACKNOWLEDGMENT

This work is supported by the *CNES* (Centre National d'études spatiales) and the *DGA* (Direction Général de l'Armement).

REFERENCES

- [1] H. Bode, *Network Analysis and Feedback Amplifier Design*. Van Nostrand, 1945.
- [2] R. M. Fano, *Theoretical Limitations on the Broadband Matching of Arbitrary Impedances*, ser. Technical report: Research Laboratory of Electronics. MIT Res. Lab. of Electronics, 1947.
- [3] D. Youla, *A new theory of broadband matching*. Defense Technical Information Center, 1964.
- [4] J. W. Helton, "Non-euclidean functional analysis and electronics," *Bulletin (New Series) of the American Mathematical Society*, pp. 1–64, 1982.
- [5] D. Martínez Martínez, G. Bose, F. Seyfert, and M. Olivi, "Convex optimisation method for matching filters synthesis," in *2nd URSI AT-RASC (Atlantic Radio Science)*, Gran Canaria, Spain, May 2018. [Online]. Available: <https://hal.inria.fr/hal-01909586>
- [6] L. Baratchart, M. Olivi, and F. Seyfert, "Boundary Nevanlinna-Pick interpolation with prescribed peak points. Application to impedance matching," *SIAM Journal on Mathematical Analysis*, 2017.
- [7] D. M. Martínez, F. Seyfert, A. Cooman, and M. Olivi, "Software PUMA-HF: <https://project.inria.fr/puma/>" 2008. [Online]. Available: <https://project.inria.fr/puma/>
- [8] B. L. Jonsson, S. Shi, L. Wang, F. Ferrero, and L. Lizzi, "On Methods to Determine Bounds on the Q-Factor for a Given Directivity," *IEEE Transactions on Antennas and Propagation*, 2017.

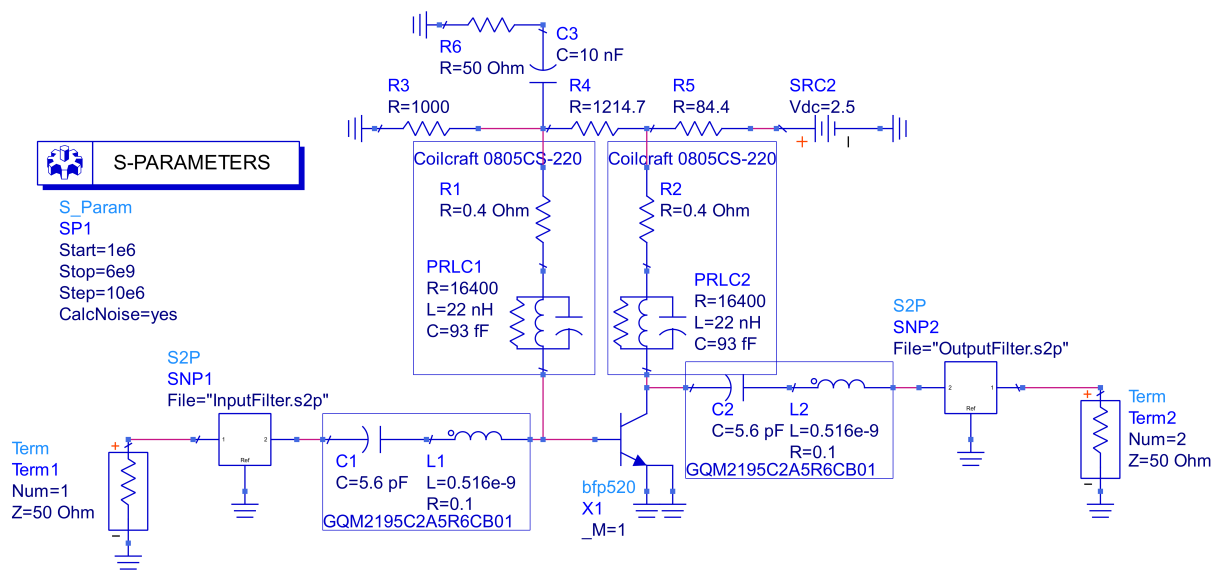

Fig. 14. Global schematic of the LNA with input and output matching networks.