



HAL
open science

Simulation by Harmonic Balance Techniques of Non-Linear Circuits Driven by Random Modulated Signals

G. Neveux, Denis Barataud

► **To cite this version:**

G. Neveux, Denis Barataud. Simulation by Harmonic Balance Techniques of Non-Linear Circuits Driven by Random Modulated Signals. 2024 19th European Microwave Integrated Circuits Conference (EuMIC), Sep 2024, Paris, France. pp.83-86, 10.23919/EuMIC61603.2024.10732393 . hal-04797210

HAL Id: hal-04797210

<https://unilim.hal.science/hal-04797210v1>

Submitted on 22 Nov 2024

HAL is a multi-disciplinary open access archive for the deposit and dissemination of scientific research documents, whether they are published or not. The documents may come from teaching and research institutions in France or abroad, or from public or private research centers.

L'archive ouverte pluridisciplinaire **HAL**, est destinée au dépôt et à la diffusion de documents scientifiques de niveau recherche, publiés ou non, émanant des établissements d'enseignement et de recherche français ou étrangers, des laboratoires publics ou privés.

Simulation by Harmonic Balance Techniques of Non-Linear Circuits Driven by Random Modulated Signals.

G. Neveux ^{#1}, D. Barataud ^{#2}

[#] XLIM Laboratory, UMR CNRS n°7252, University of Limoges, France
{¹guillaume.neveux, ²denis.barataud}@xlim.fr

Abstract — A new method is proposed to perform, by Harmonic Balance (HB) techniques, the simulation of non-linear circuits driven by carrier Random-Modulated (RM) signals. The microwave driving random modulated generator is first transformed in an almost periodic generator with two fundamental frequencies: the carrier frequency (f_{car}) and, on the other hand, the modulating frequency ($f_{modframe}$) given by the user-defined length ($T_{modframe}$) of the modulating random bit sequence. This random bit sequence is mapped into a random symbol sequence with a symbol period (T_{symb}). The random modulated generator becomes then a Pseudo-Random Modulated (PRM) microwave signal generator. An almost-periodic harmonic balance simulation can be then performed with this driving microwave PRM generator. This paper presents the implementation of the PRM microwave generator in a commercially available circuit simulation software. A software-defined demodulation of the output signal of the DUT, with optimal matched filters to respect the Nyquist criteria, is implemented to extract all the linearity and power metrics performances at design circuit level, in the time and frequency-domains. To check the validity of the PRM-HB simulation, a linear circuit driven by a 16 QAM modulated microwave signal is simulated and the EVM is calculated.

Keywords — circuit simulation; demodulation; frequency-domain analysis; harmonic balance; linearity; modulation; non-linear circuits; pseudo-random generation

I. INTRODUCTION

Today, in more and more applications, as in the new telecommunication standards (5G and beyond), the carrier frequency increases towards millimeter bands, and the modulations become more and more complex. Therefore, it is mandatory that designers have an accurate and reliable software design tool allowing, in the same HB simulation-frame, the simulation of RF components or subsystems with Continuous Wave (CW) or with modulated RF sources. In [1], the HB solver couldn't give the solution using the classical Newton-Raphson technique and the direct inversion of the Jacobian matrix for HB simulations with a high number of frequencies. Later, to overcome this issue, [2] proposed an "inexact Newton Harmonic Balance" method. Most recently, [3] and [4] give some examples of multi-dimensional HB method. For instance, in [5], after periodizing the input signal, a transient stimulation by piecewise HB techniques is performed. Today, thanks to the work of many mathematicians [6], [7], [8] or [9], commercially available simulators allow the HB simulation of circuits with a

number of nodes exceeding several hundred thousand and millions of equations to be solved. Therefore, these simulations can now be performed under periodic and almost-periodic regimes with reasonable computation time, with one to three non-harmonically related fundamental frequencies. Besides, using a unified simulation-frame allows the use of the circuit-element models defined in the frequency-domain. Their accurate time-domain counterpart, necessary for the simulation of modulated signals by circuit-envelope, are not always available and they require then an additional extraction of time-domain models transformed to frequency-domain of S-parameters. Using a unified simulation-frame, designers will be able to switch easily from one kind of simulation to another one without having to modify their workspace. The application of a unified, simulation method, at circuit and system level, leveraging Harmonic Balance technique is proposed here and constitutes a major innovation for designers of microwave non-linear devices (Amplifiers, mixers, oscillators for example).

In the hereby-proposed methodology, the pseudo-random modulated (PRM) signals are generated by periodizing the pseudo-random symbol sequences allowing almost periodic HB. Thanks to the continuous improvements of the software and computer performances, we propose and present a general methodology to perform a whole simulation of non-linear circuits driven by PRM microwave signals in the frame of almost-periodic HB. In this simulation method, the PRM microwave signals are generated by periodizing the pseudo-random bit sequences allowing almost periodic HB.

The general principle of the proposed method to perform the simulation by HB techniques of Pseudo-Random-Modulated signals (PRM-HB) is described in Fig. 1. The paper details the design flow graph and the description of the whole process of the PRM-HB. It explains the generation of the pseudo-random bit sequence, the generation of the modulated carrier, up to the generation of the output DUT data.

Finally, the demodulation process is described. It allows the calculation and the plots of the dynamical results such as the Error Vector Magnitude (EVM) or the Adjacent Channel Power Ratio (ACPR). The calculations are performed by adding specific in-house XLIM-defined functions using the Application Extension Language (AEL) programming language.

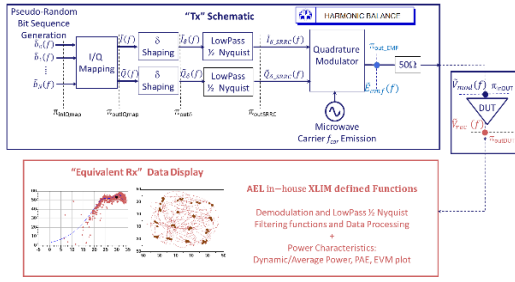

Fig. 1. Principle of the proposed PRM-HB simulation.

II. PSEUDO-RANDOM-MODULATED HARMONIC BALANCE (PRM-HB) PROCESS

A. Fundamental Definitions of pseudo-random modulated signals in the frame of almost-HB Simulations.

Any modulated voltage signal can be written as follows [9]:

$$v_{mod}(t) = A(t) \cos(2\pi f_{car}t + \varphi(t)) \text{ with } A(t) \geq 0 \quad (1)$$

Traditionally, equation (1) is often written as follows:

$$v_{mod}(t) = I(t) \cos(2\pi f_{car}t) - Q(t) \sin(2\pi f_{car}t) \quad (2)$$

$$v_{mod}(t) = \Re\{[I(t) + jQ(t)]e^{j2\pi f_{car}t}\} \quad (3)$$

In (3), $I(t)$ and $Q(t)$ respectively represent the "In phase" and "in Quadrature" modulating voltage signals from which it is possible to define the complex envelope $\tilde{v}_{mod}(t)$ of the voltage $v_{mod}(t)$, at the carrier frequency f_{car} as described in (4) and (5):

$$\tilde{v}_{mod}(t) = I(t) + jQ(t) \quad (4)$$

$$\tilde{v}_{mod}(t) = A(t)e^{j\varphi(t)} \text{ with } A(t) \geq 0 \quad (5)$$

To perform the PRM-HB simulation, the modulated voltage signal described in (1) must be a 2D-periodic signal with two fundamental frequencies. To fulfill this condition, f_{car} is naturally chosen as one of the two fundamental frequencies. On the other hand, the length of the pseudo-random bit sequence ($T_{modframe}$) defines the period of the second fundamental frequency $f_{modframe}$. For an M-QAM modulation, with M complex levels, the frame length corresponds to an integer number of M.

The expanded expression of the almost periodic modulated periodic voltage signal $v_{mod}(t)$, limited to K harmonics, then defined as $v_{modK}(t)$, can be written as:

$$v_{modK}(t) = \sum_{k=-K}^{k=K} A_k \cos(2\pi(f_{car} + kf_{modframe})t + \varphi_k) \quad (6)$$

B. Implementation of an M-QAM modulated signal generator in the frame of almost-Harmonic Balance.

In the PRM-HB simulation of a non-linear circuit, as shown in Fig. 1, all voltages or currents of the circuit are represented by the following waveforms:

$$v_{modN,K'}(t) = \Re\left\{\sum_{n=0}^{n=N} \left[\sum_{k=-K'}^{k=K'} (A_{k,n} e^{j\varphi_{k,n}}) e^{j2\pi k f_{modframe} t}\right] e^{j2\pi n f_{car} t}\right\} \text{ with } n f_{car} + k f_{modframe} \geq 0 \quad (7)$$

This last equation represents the truncated 2D Fourier series expansion of a modulated signal with N the number of harmonics of the carrier frequency f_{car} and K' the number of harmonics of the periodic modulating signal with a fundamental frequency $f_{modframe}$ and limited itself to K harmonics. K' is

introduced because the non-linear circuit generates harmonics of the K -limited complex envelope, around f_{car} .

Eq. (8) can also be written as:

$$v_{modN,K'}(t) = \sum_{n=0}^{n=N} \sum_{k=-K'}^{k=K'} A_{n,k} \cos[2\pi(n f_{car} + k f_{modframe})t + \varphi_{n,k}] \text{ with } n f_{car} + k f_{modframe} \geq 0 \quad (8)$$

The previous definitions are applied to generate a specific M-QAM example ($M = 16$) at the output of the PRM Generator. Fig. 2 presents the schematic used to implement the 16-QAM modulated signal generator with $N_{bit} = 4$.

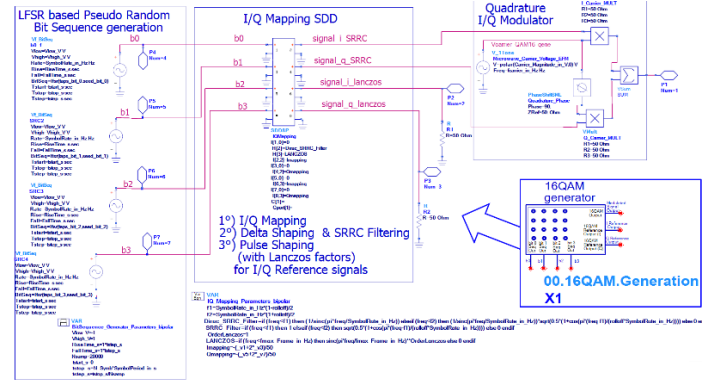

Fig. 2. Schematic of an in-house XLIM 16-QAM modulated signal generator and its associated symbol.

The implementation of the 16-QAM modulated signal thanks to the PRM generator starts with the generation of frequency-domain defined \tilde{b}_0 , \tilde{b}_1 , \tilde{b}_2 and \tilde{b}_3 PRBS with equiprobability of the generated symbols on the frame length $T_{modframe}$. Fig. 3 presents the associated time-domain representation of \tilde{b}_0 , \tilde{b}_1 , \tilde{b}_2 and \tilde{b}_3 . In this figure, we also add the optimal sample time corresponding to the maximum opening eye diagram

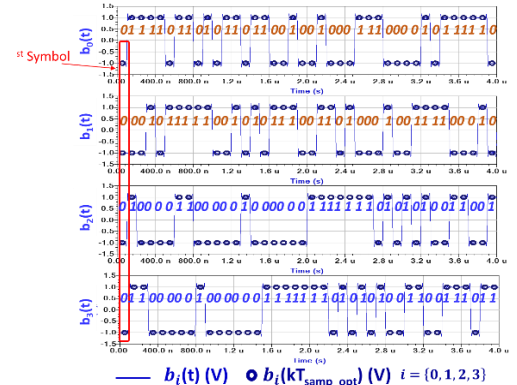

Fig. 3. $b_0(t)$, $b_1(t)$, $b_2(t)$, $b_3(t)$ representation after running PRM-HB.

From the optimal sample time, the different state symbols can be determined as the first Symbol highlighted in Fig. 3. The constellation diagram with the 16 different symbol states can then be plotted as in Fig. 4. This figure indicates that a natural binary code is arbitrary selected. The next steps of the implementation of the 16-QAM modulated signal consist in creating and realizing: 1°) the IQ mapping (generation of a $\{\tilde{I}(f); \tilde{Q}(f)\}$ couple); 2°) the Delta shaping Filtering ($\delta_{shaping}(f) = 1/\text{sinc}(f/s_{ymb}R_{ate})$) used to generate a $\{\tilde{I}_\delta(f); \tilde{Q}_\delta(f)\}$ couple); 3°) the half Nyquist filtering (Square

Root Raised Cosine Filter usually used in telecommunication systems allowing the generation of a $\{\tilde{I}_{\delta_SRRC}(f); \tilde{Q}_{\delta_SRRC}(f)\}$ and 4°) the quadrature IQ modulation.

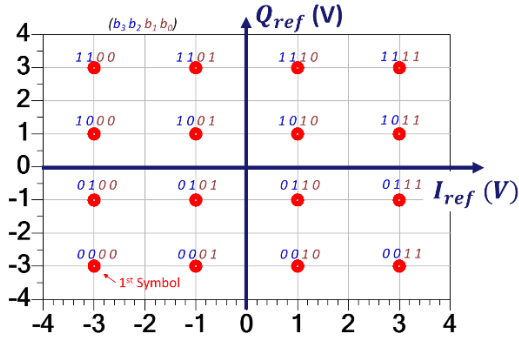

Fig. 4. Constellation Diagram of the implemented truncated 16-QAM modulated voltage signal based on 4 Pseudo-Random Bit Sequence generators.

A last I/Q reference couple called $\{\tilde{I}_{ref}(f); \tilde{Q}_{ref}(f)\}$ is generated thanks to a Lanczos sigma factor filtering function applied on to the $\{\tilde{I}_{\delta_SRRC}(f); \tilde{Q}_{\delta_SRRC}(f)\}$ data. This function drastically reduces the Gibbs phenomena so that the output signals can be used as reference signals to perform the later EVM calculation. Fig. 5 presents, as example, on the top left, the comparison between the time-domain $\delta_{shaping}/SRRC$ filtered $\{I_{\delta_SRRC}(t); Q_{\delta_SRRC}(t)\}$ signals and the reference Lanczos filtered $\{I_{ref}(t); Q_{ref}(t)\}$ signals. The associated spectra of these signals are shown on the top right. The two other curves at the bottom of the Fig. 5 show the corresponding magnitude and phase of $\tilde{e}_{emf}(t)$ and $\tilde{v}_{ref}(t)$.

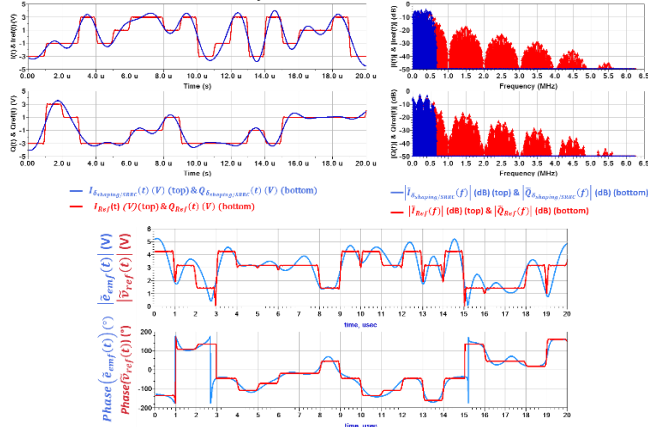

Fig. 5. $\delta_{shaping}/SRRC$ filtered $I(t)$ and $Q(t)$ signals and reference $I_{ref}(t)$ and $Q_{ref}(t)$ signals (Top Left). Associated spectra (Top Right). Bottom: Corresponding Magnitude and phase of $\tilde{e}_{emf}(t)$ and $\tilde{v}_{ref}(t)$.

C. Demodulation and EVM calculation after PRM-HB Simulation.

The demodulation process is not performed in the schematic with a quadrature demodulator but it is realized thanks to a post-processing carried out in a “data display” window and it corresponds, in our example, to the digital reception of a 16-QAM modulated signal. The post-processing is based on Application Extension Language (AEL) functions specifically developed and implemented at XLIM. It consists in 6 steps. The 1st one consists in calculating the envelopes, around f_{car} , of the

frequency-domain probe voltages $\tilde{V}_{mod}(f)$ at the input of the DUT and at its output $\tilde{V}_{rec}(f)$ (Fig. 1). The 2nd one consists in performing matched filtering (LowPass $\frac{1}{2}$ Nyquist), as the one used for the PRM generator. It is applied in the frequency-domain to the real and imaginary parts of the output voltages of the DUT: $\tilde{V}_{recI}(f)$, and $\tilde{V}_{recQ}(f)$ and it outcomes a filtered received envelope $\tilde{v}_{rec_RC}(t)$. The 3rd step consists in implementing the technique to determine the optimal sampling instant useful to recover the symbol frame. This technique is based on the estimation of the delay and the correction of the static errors of all the symbols in $\tilde{v}_{rec_RC}(t)$ when the voltage gain and the delay of the DUT are not beforehand a priori known. The outcome is a filtered and optimally sampled envelope $\tilde{v}_{rec_RC_samp}(p)$. The 4th step consists in determining 6 static error coefficients due to the application of the matching filters and the optimal sampling. The knowledge of the static error coefficients allows the final correction of the sampled envelope ($\tilde{v}_{rec_RC_samp}(p)$) and the calculation of the corrected trajectory $\tilde{v}_{rec_RC_corr}(t)$ from the received RC filtered trajectory $\tilde{v}_{rec_RC}(t)$ in the step 5. After applying these corrections, the corrected vector diagram $\tilde{v}_{rec_RC_samp_corr}[p]$ and the corrected received RC filtered trajectory $\tilde{v}_{rec_RC_corr}(t)$ can be calculated and overlaid as shown in the next paragraph.

III. VERIFICATION OF THE PRM-HB SIMULATION METHOD WITH A LINEAR DEVICE UNDER TEST

In order to check the whole PRM-HB simulation frame, it is first applied to a linear Device Under Test (DUT) which is a linear current controlled voltage source with a constant transconductance g_m and a fixed delay (associated to a phase shift). The previous truncated 16-QAM modulated voltage signal $v_{modK}(t)$ feeds the DUT as shown in Fig. 6. This figure also presents the different parameters used for the simulation. The linear DUT (ideal delayed voltage controlled current source) is implemented thanks to a 2-port Symbolically Defined Device. Input and output ports present a 50Ω impedance. A 50Ω one-port load is connected at the output of the linear DUT. The g_m transconductance is chosen equal to 0.2 S so that the magnitude of the linear complex voltage gain ($\tilde{G}_{vlinDUT}$) is equal to 5. The delay (τ_{DUT}) is chosen, in this example, equal to 23.4 ns . With a 10 MS/s symbol rate, G_{linDUT} remains constant and equal to 5. The constant delay of the DUT induces a -36° carrier phase shift ($\varphi_{car} = -36^\circ$) at 3.5 GHz , imposing an anticlockwise rotation of the output constellation diagram of the linear DUT by the same 36° angle value. After running the PRM-HB simulation and the 6 steps of the demodulation process described in the previous paragraph, the corrected vector diagram $\tilde{v}_{rec_RC_samp_corr}[p]$ and the corrected received RC filtered trajectory $\tilde{v}_{rec_RC_corr}(t)$ can be overlaid as shown in Fig. 7. The constellation is now ready to be compared with the 16QAM Reference Vector Diagram for EVM calculation as presented in Fig. 8. The two vector diagrams are perfectly matched and overlaid for the linear DUT driven by the modulated 16-QAM previously defined voltage. The root mean square normalized EVM is then calculated as:

$$EVM_{RMS} (\%) = \frac{\sqrt{\sum_{p=1}^{N_{symb}} |\tilde{v}_{rec_RC_samp_corr}[p] - \tilde{v}_{ref}[p]|^2}}{\sqrt{\sum_{p=1}^{N_{symb}} |\tilde{v}_{ref}[p]|^2}} \quad (9)$$

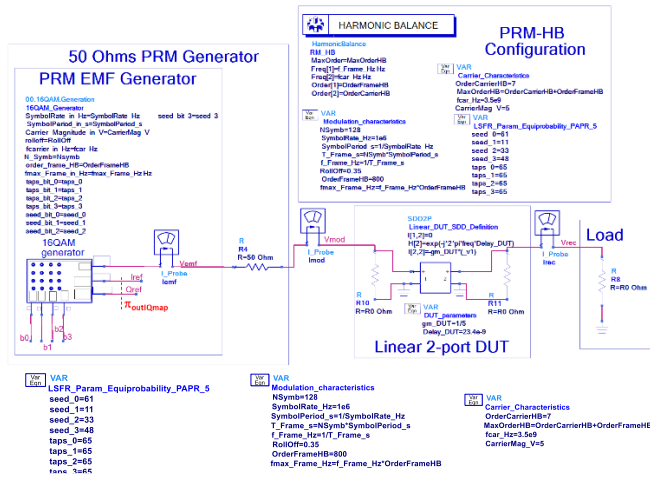

Fig. 6. Example of operating PRM-HB simulation of a linear non-dispersive DUT driven by a 16-QAM modulated voltage

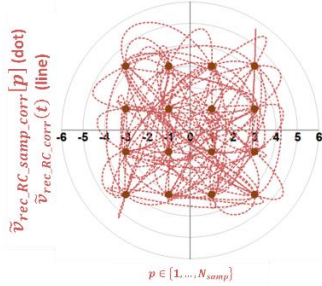

Fig. 7. Corrected 16-QAM Vector Diagram $\tilde{v}_{rec_RC_samp_corr}[p]$ and the received RC filtered Trajectory $\tilde{v}_{rec_RC_corr}(t)$.

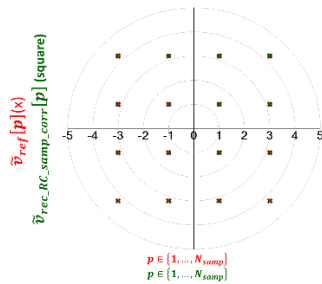

Fig. 8. Corrected 16-QAM Vector Diagram $\tilde{v}_{rec_RC_samp_corr}[p]$ and 16-QAM reference vector Diagram.

Fig. 9 shows the result of the EVM_{RMS} calculated for $\tilde{v}_{rec_RC_samp_corr}[p]$ with a data display equation associated to (9).



Fig. 9. EVM calculated for $\tilde{v}_{rec_RC_samp_corr}[p]$.

For the linear DUT driven by the modulated 16QAM, the EVM_{RMS} is very low and equal to 0.0016% at its input and output ports. As originally anticipated, the EVM criterion as linearity metric is not affected by a linear DUT. This EVM value validate the 6 steps of the post-processes implemented

after the PRM-HB simulation. Note that these values analytically calculated have exactly the same results.

IV. CONCLUSION

In this paper, a new method called PRM-HB is introduced and proposed to simulate, at circuit level and by Harmonic Balance techniques, non-linear circuits driven by Random-Modulated microwave signals. The validity of this method has been demonstrated in this part with the simulation of a linear DUT with memory. The core of the paper is to demonstrate that a linearity criterion as the EVM is, for the first time, determined by Harmonic Balance Techniques at circuit level. The main interest of this PRM-HB technique lies in the fact that the dynamic metrics and associated criteria can be evaluated during the circuit-based design process. In [10], a deepen analysis of the PRM-HB method is presented to simulate a designed MMIC GaN Doherty Power Amplifier (DPA) driven by the same 16-QAM modulation.

ACKNOWLEDGMENT

The authors are indebted to Professor J. Obregon for many discussions they shared with him.

REFERENCES

- [1] John F. Sevic, Michael B. Steer, Anthony M. Pavio, "Non Linear Analysis Methods for the Simulation of Digital Wireless Communication Systems", *International Journal of Microwave and Millimeter-Wave Computer-Aided Engineering*, vol. 6, N° 3, 1996, pp. 197-216, doi:10.1002/(SICI)1522-6301(199605)6:3<197::AID-MMCE5>3.0.CO;2-O - Corpus ID: 62591359.
- [2] V. Rizzoli, C. Cecchetti, D. Masotti and F. Matri, "Nonlinear processing of digitally modulated carriers by the inexact-Newton harmonic balance technique," in *Electronics Letters*, vol. 33, no. 21, pp. 1760-1761, 9 Oct. 1997, doi: 10.1049/el:19971223.
- [3] Zhijie Charles Chen, Bingyi Wang, Daniel Palanker, "Harmonic-Balance Circuit Analysis for Electro-Neural Interfaces", *Journal of Neural Engineering*, accepted manuscript online 16 avril 2020, 2020 IOP Publishing Ltd, <https://doi.org/10.1088/1741-2552/ab89fd>.
- [4] Janis Eidaks, Romans Kusnins, Ruslans Babajans, Darja Cirjulina, Janis Semenjako, and Anna Litvinenko. "Fast and Accurate Approach to RF-DC Conversion Efficiency Estimation for Multi-Tone Signals" *Sensors* 22, no. 3: 787, 2022. <https://doi.org/10.3390/s22030787>
- [5] B. G. Galerkin, "Series Solutions of Some Problems of Elastic Equilibrium of Rods and Plates" (title translated from Russian), *Vestnik Ingenerov* (Petrograd, Russia), no. 19, p. 897; 1915.
- [6] F. Bizzarri, A. Brambilla and L. Codecasa, "Reduction of harmonic balance equations through Galerkin's method," *2015 European Conference on Circuit Theory and Design (ECCTD)*, 2015, pp. 1-4, doi: 10.1109/ECCTD.2015.7300089.
- [7] A. N. Krylov, "On the numerical solution of the equation by which the frequency of small oscillations is determined in technical problems", *Izv. Akad. Nauk SSSR, Ser.Fiz.-Mat.*, 4 (1931), pp. 491-539. In Russian. Title translation as in F. R. Gantmacher, "The Theory of Matrices." Vols. 1 and 2, Chelsea Publishing Co., New York, 1959
- [8] Y. Saad, M. H. Schutz, "GMRES: a generalized minimal residual method for solving non symmetric linear systems" *SIAM, J. Sci. Stat. Comput.*, vol. 7, Oct. 1986, pp. 856-869, <https://doi.org/10.1137/0907058>.
- [9] Vaezi, A., Abdipour, A. and Mohammadi, "Nonlinear analysis of microwave amplifiers excited by multicarrier modulated signals using envelop transient technique". *Analog Integr Circ Sig Process* 72, 313-323 (2012). <https://doi.org/10.1007/s10470-012-9880-1>.
- [10] Hallepee C., Passerieux D., Neveux G., Barataud D. "Frequency-Domain Simulation and Time-Domain Measurements of a GaN Amplifier driven by M-QAM modulated carrier generator." Submitted to 2024 54th European Microwave Conference, 2024.